

# INFORMATION FOR FIRST AND SECOND RESPONDERS.

## EMERGENCY RESPONSE GUIDE FOR VEHICLE

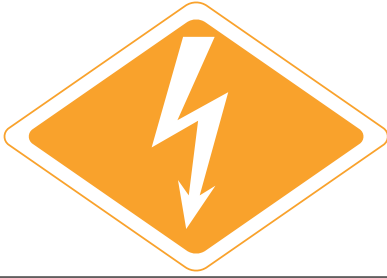

Alexander Dennis Enviro100EV

Battery-Electric Vehicle

Electric Motor Propulsion



# Enviro100EV



## Contents

Example Rescue Sheet .....	Page 4
1. Propulsion Identification .....	Page 5 - 7
2. Immobilisation / Stabilisation / Lifting .....	Page 8 - 9
3. Disable Direct Hazards / Safety Regulations .....	Page 10 - 12
4. Access to the Occupants .....	Page 13 - 14
5. Stored Energy .....	Page 15 - 18
6. In Case of Fire .....	Page 19 - 22
7. In Case of Submersion .....	Page 23
8. Towing / Transportation / Storage .....	Page 24 - 27
9. Important Additional Information .....	Page 28
10. Explanation of Pictograms Used .....	Page 29
Safety Data Sheets .....	Appendix

Download this, and other safety documents, from <https://www.ad24.direct/emergency-response>



# Rescue Sheet

This provides necessary and useful information about a vehicle involved in an accident/incident to support the rescue team in rescuing the vehicle occupants as quickly and safely as possible. It should be used by first responders to assist in making a safe rescue plan. The full version is available as a separate document.



**Alexander Dennis**  
**Enviro100EV**  
**Single Door,**  
**Single-deck Body**  
**2024/-**

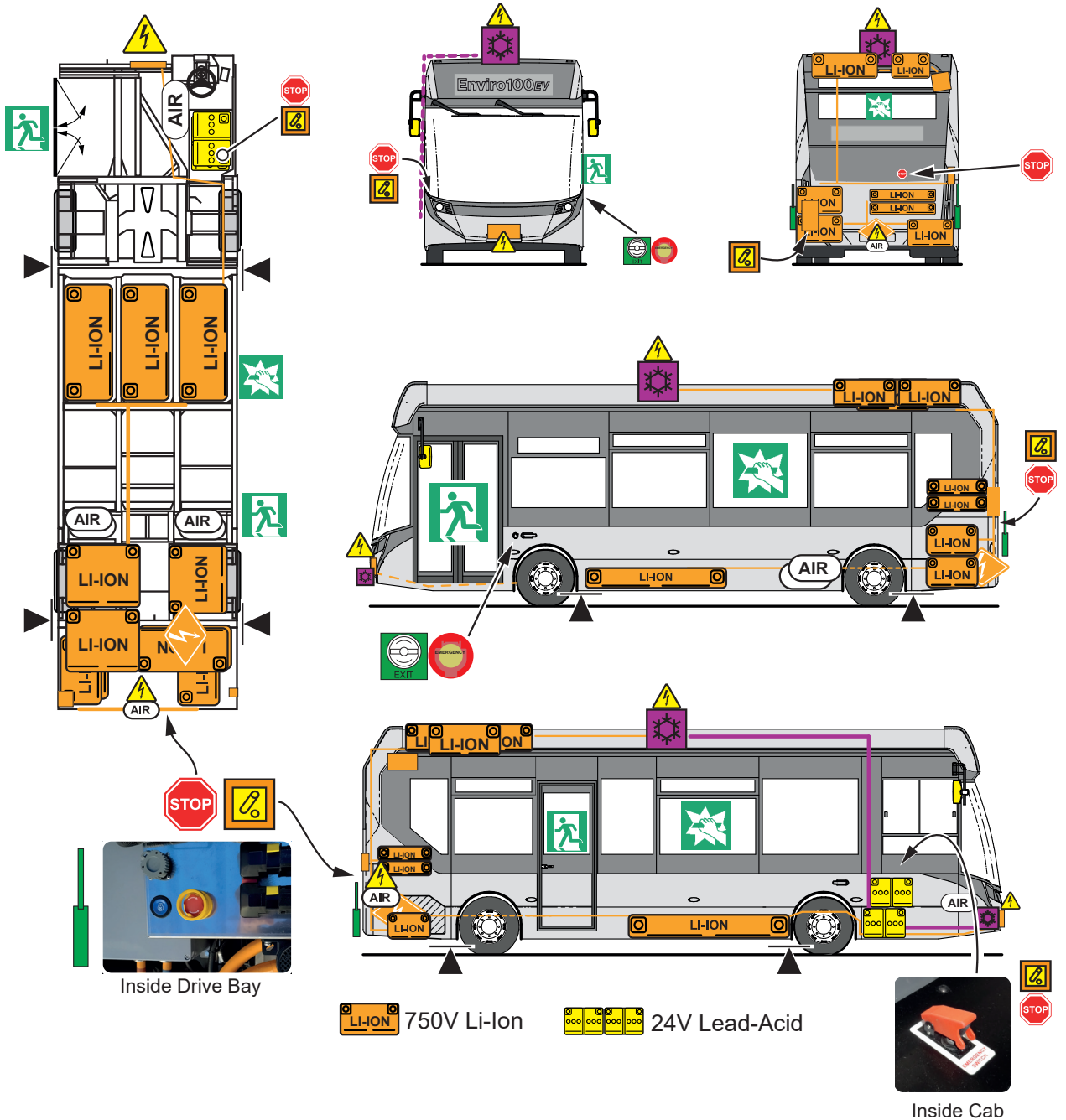
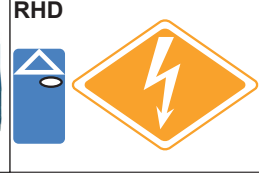

Low Voltage Battery	High Voltage Battery	Electric Drive	High Voltage Junction Box	High Voltage Cable	Compressed Air Tank	HV Disable	Emergency Exit	Break Glass Exit
24v Battery Disconnect	Emergency Stop Switch	Door Control	Electric Air Compressor	BTMS Air Conditioning	High Voltage Electrics	High Pressure Gas Struts	Lifting Point	

## 1. Propulsion Identification

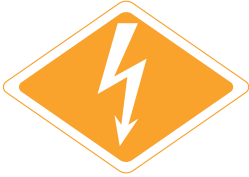

Li-Ion / NMC Battery - Electric bus

**CAUTION:** Lack of noise does not mean vehicle is off:  
Silent movement or instant restart capability exists until vehicle is fully shut down

### Vehicle Description

The Enviro100EV is a fully electric powered, two axle, one door, single deck midibus. The vehicle is fitted with 11 re-chargeable battery packs of 236 KWh or 354KWh. The vehicle is driven by a water-cooled, permanent magnet, Voith Electrical Drive System (VEDS) HD Electric Motor with a high-efficiency inverter.

If there is a model badge on the vehicle it may look like one of the following pictures.

Not all models will display all the badges

## Enviro100EV

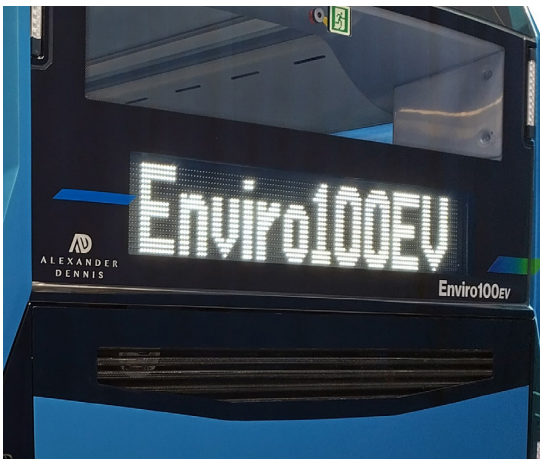

### Vehicle Identification

There is an identification plate located inside the front door on the right hand bulkhead.

This plate gives details of:

- Manufacturer
- Model
- Permitted Weights
- VIN number

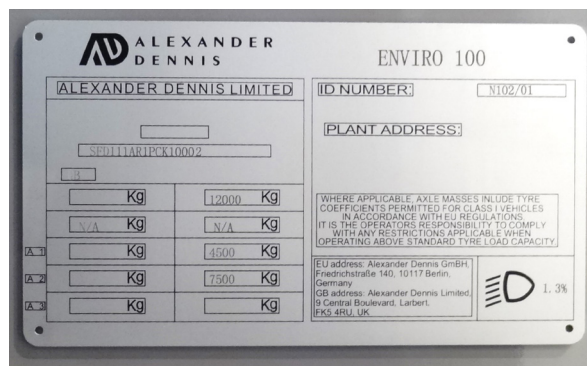

### Battery Pack (REESS) Details

11 x NMC lithium-ion battery packs

Chemical class: ADR Class 9A – miscellaneous dangerous goods

Nominal operating voltage: 750VDC



# 1. Propulsion Identification

## Critical Component Locations (Vehicle Exterior).

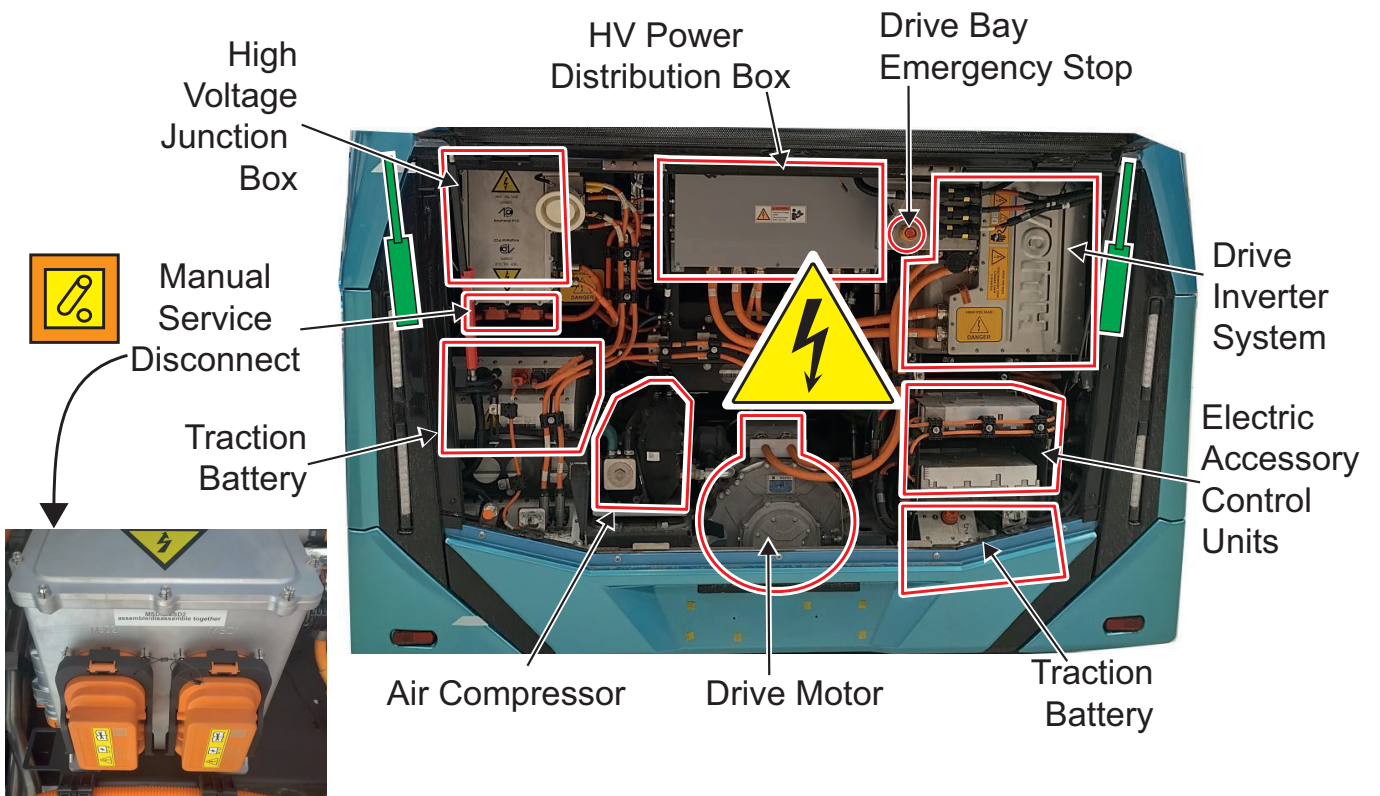
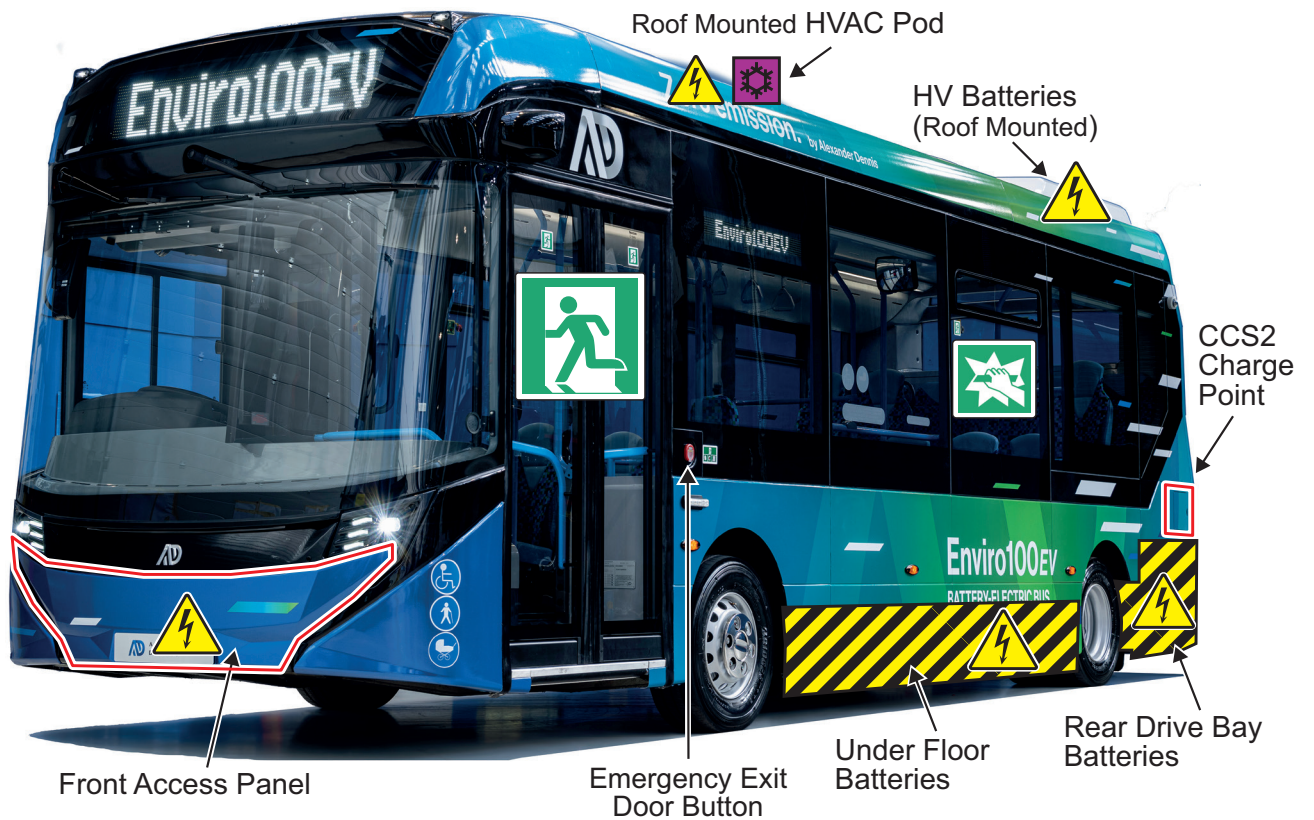

# 1. Propulsion Identification

## Chassis HV and equipment Layout.

NOTE: HV shocks are a potential risk where any component damage is suspected.

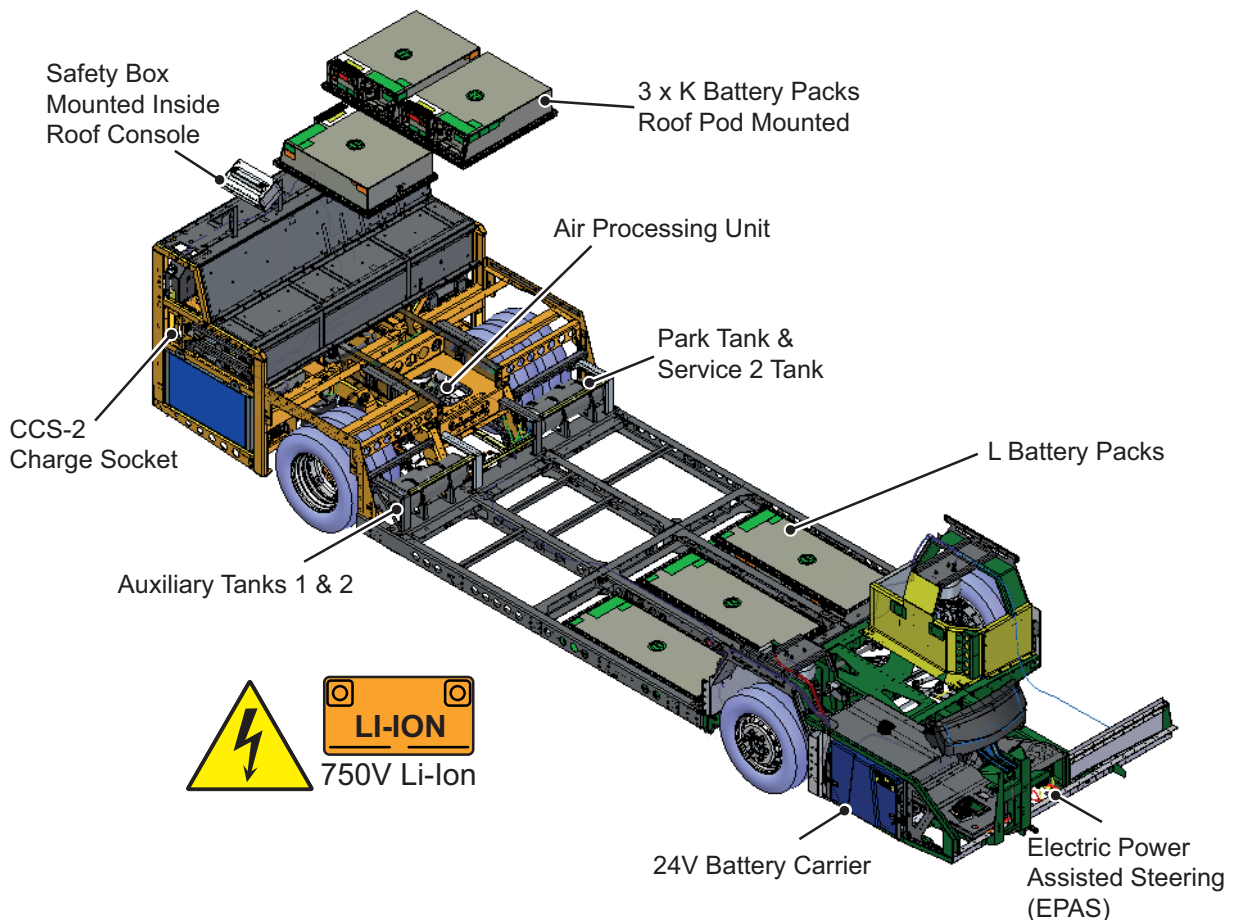
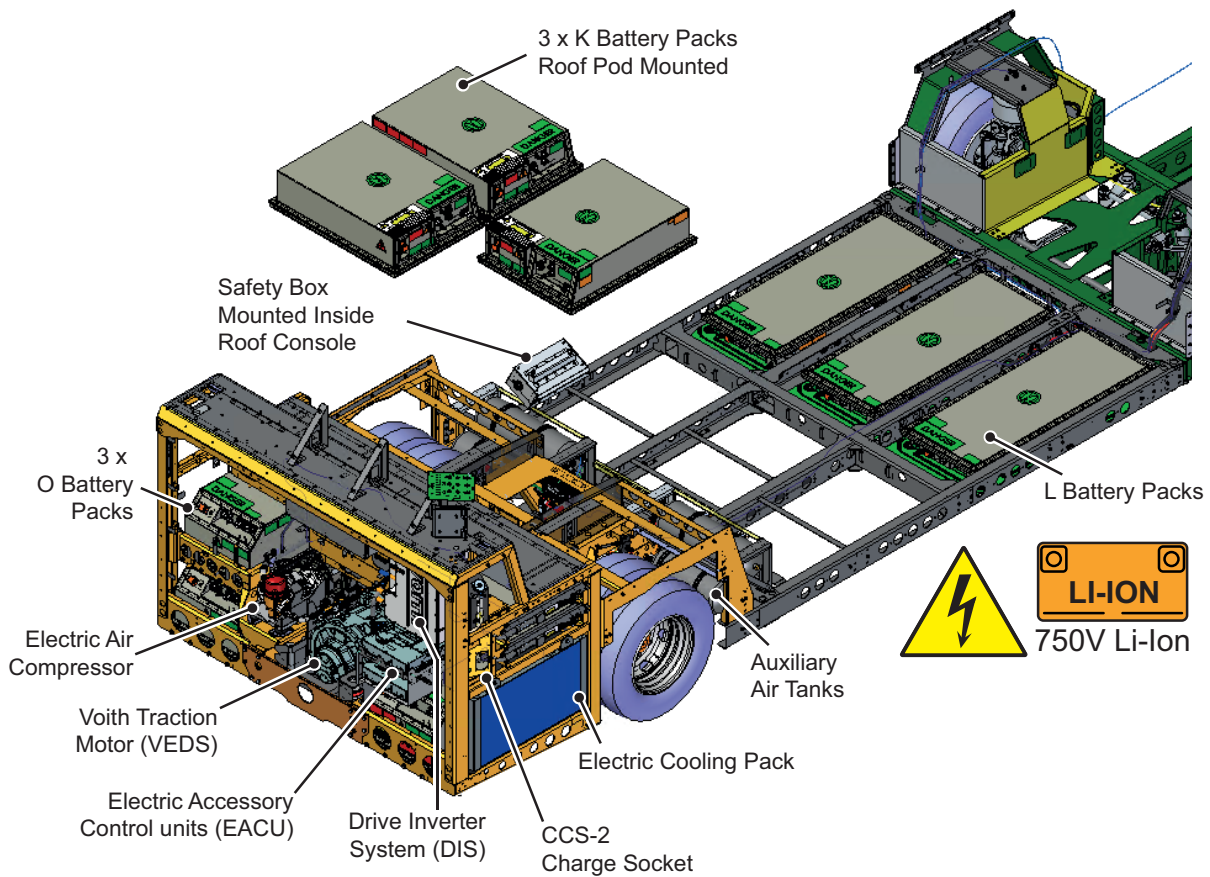

## 2. Immobilisation / Stabilisation / Lifting

Suspension height controls are located on the right hand side of the driver's switch console

### Suspension Controls.



Access to the suspension control is from within the driver's cab.

**NOTE:** These controls only operate when the vehicle is fully powered on.



### For front kneeling:

Press and hold the lower switch until lowering reaches required level.

Press the upper switch once and the vehicle will return to normal ride height.

Suspension  
raise.



Suspension  
front kneel.

### Preventing Vehicle Motion.

Ensure the parking brake is applied before leaving the vehicle.

Where this is not possible, the wheels should be chocked to prevent any unwanted movement.



### **⚠ WARNING:**

In the event of electrical failure, the Electronic Parking Brake will not respond and wheel chocks **MUST** be used to prevent runaway.



## 2. Immobilisation / Stabilisation / Lifting

### Lifting points.

Lift the bus as indicated in the below illustration - behind the front axle and just behind the rear axle. Attempting a lift elsewhere carries a high risk of damage.



Single door body pictured here, lifting points are as marked.

Do not lift forward of the front axle, forward of the rear axle or in the centre of the body as the structure in these locations is unsuitable for supporting the weight of the vehicle. The lift will be unstable and may cause damage or injury to personnel

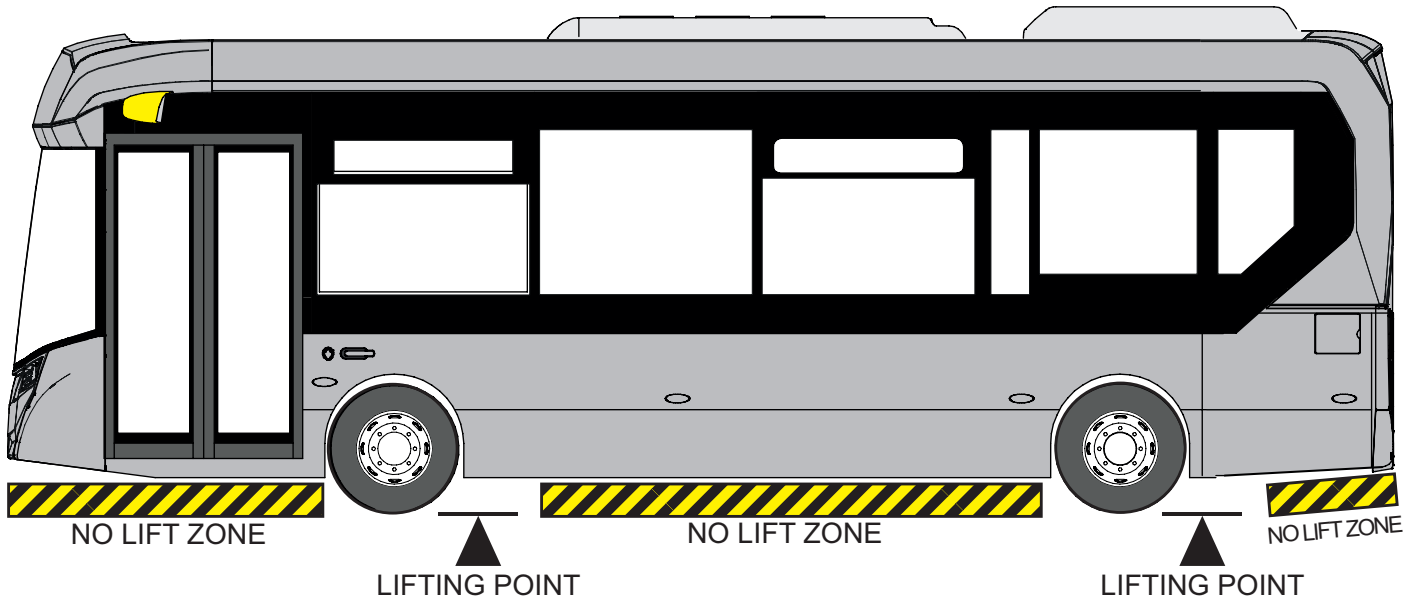

### Stabilisation points / chassis support points

Lifting equipment should be applied to the jacking points on the chassis frame.



Front RHS Jacking Point



Rear RHS Jacking Point.

### Chassis Support Locations

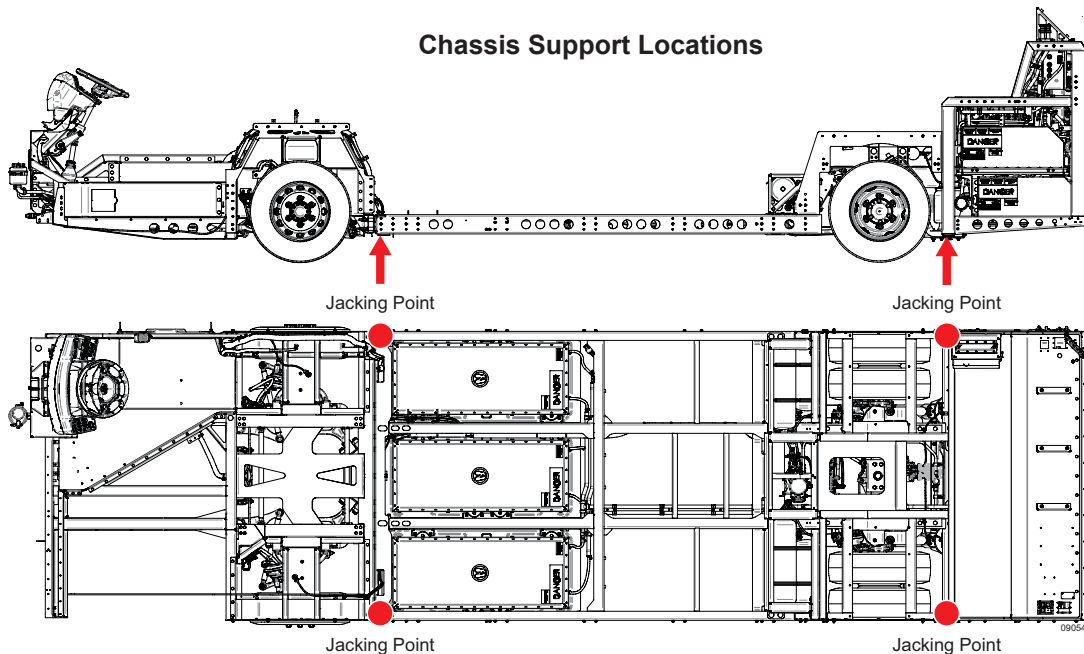

### 3. Disable Direct Hazards / Safety Regulations

**CAUTION:** Always engage the parking brake before leaving the cab OR chock the wheels to prevent movement.

#### Vehicle Safe Shutdown Procedure.

**1** Select Neutral.



**2** Apply the Electronic Parking Brake.

Access to the parking brake control is from within the driver's cab.

To apply the parking brake, pull the lever up. When the park brake is applied, the park symbol within the lever will illuminate **RED** and the park warning light will show in the telltale display on the instrument binnacle.

If the vehicle has no electrical power the parking brake control will not function, suitable precautions should be taken in order to prevent unintended movement. Wheel chocks should be applied to at least one wheel.

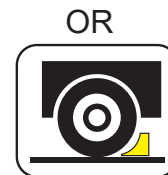
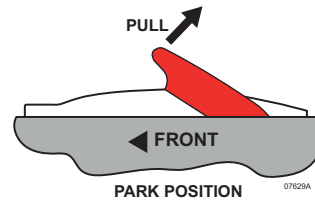

**3** Turn off Ignition:

To shut down the bus, press the lower part of the Start/Stop switch. Switch will flash during power-down, wait 10 seconds before proceeding.



**4** Turn off Master Switch:

Press and release the bottom of the switch to turn off the master switch. Switch will flash during power-off.

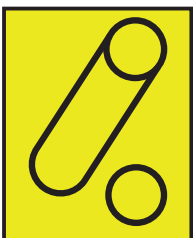

**To confirm that vehicle is powered off:**

- No illumination on instrument cluster
- No lights on master or Ignition switches



### 3. Disable Direct Hazards / Safety Regulations

#### Emergency Vehicle Shutdown (ALL HV & 24V Systems).



#### Emergency Stop: Driver's Cab.

Switch is in the side console towards the back of the driver's seat.  
Lift cover and push toggle to activate the emergency stop.

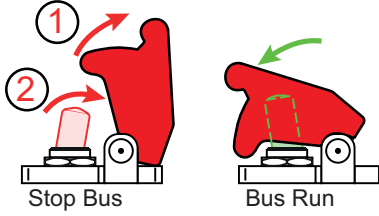

#### Emergency Stop: Rear Drive Bay.

If possible, switch off vehicle before operating.  
Lift cover: CAUTION: gas struts on lid.  
Push stop button to activate the emergency stop.  
This button can be padlocked to prevent accidental release.

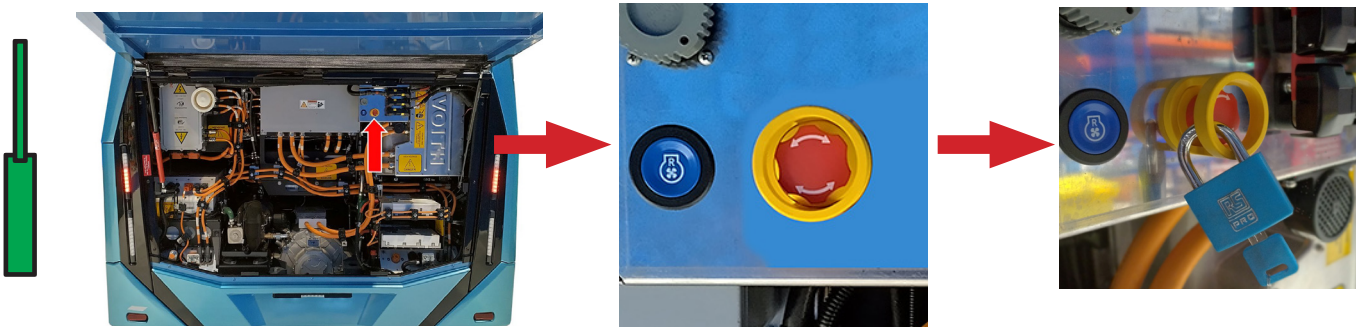

### 3. Disable Direct Hazards / Safety Regulations

#### 24V Disconnection.

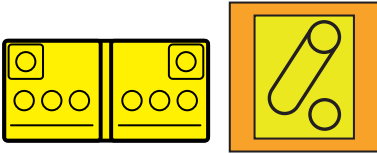

Battery access is via an access door at the front, below the driver's cab.

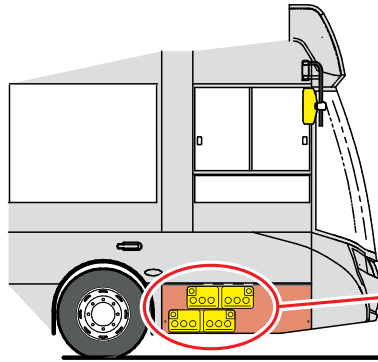

Lift and secure the access door, release the antiluce fasteners, then slide the tray out to access the battery connectors and remove the negative connection. Secure cable to prevent accidental re-connection.



#### High Voltage Disconnection.



**WARNING:**  
Do not disturb the MSD plugs if the vehicle is on charge.  
Stop and remove charge supply before touching.  
Failure to do so may result in danger to life or damage to equipment.

To access the Manual Service Disconnect plugs on the High Voltage Junction Box, open the rear drive bay door.

On both MSD plugs:

Release the locking tabs before lifting the lever to 90°.

Pull the plugs out of the High Voltage Junction Box.

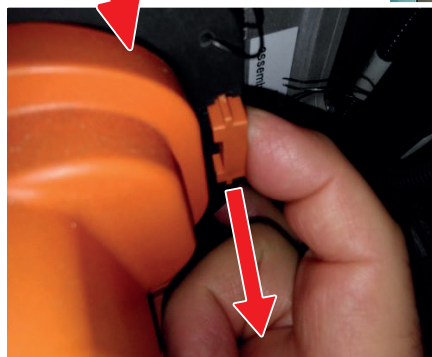
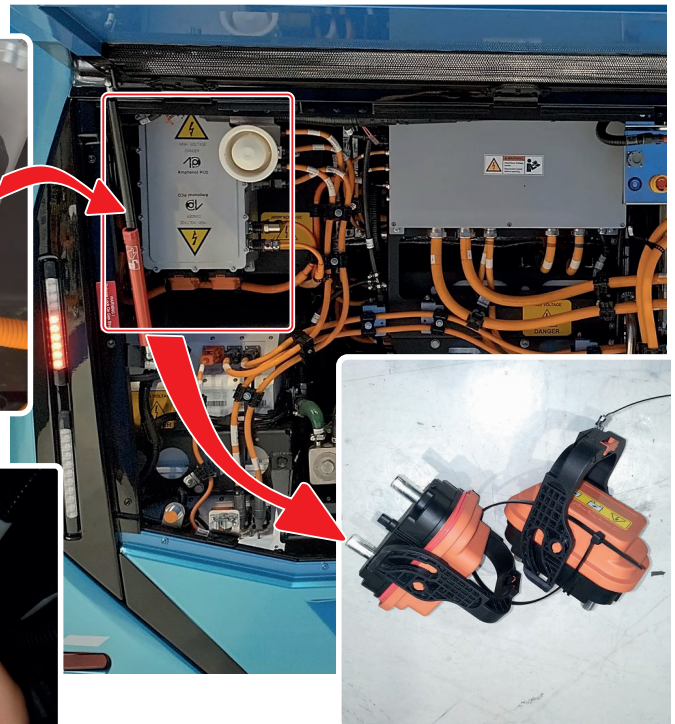

The removed plugs should be stored safely until they are needed. AD recommends placing them in a padded bag and putting them on the binnacle to prevent any accidental reconnection.

Close the access door to prevent rain or moisture ingress.

A warning should be placed on the steering wheel to indicate the vehicle is not to be powered up.



## 4. Access to the Occupants

### 1 Emergency Door Operation.



To open the door from outside:  
Push the emergency button located near the rear edge of the doors.

To open the door from inside:  
Push the emergency button located above the doors.  
Lift the flap and push the button.

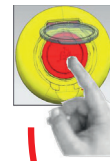

External Emergency Exit Button



Internal Emergency Exit Button

### Door Operation Failure.

If the doors do not operate they can be pushed open manually.  
It may be necessary to exhaust any remaining air in the auxiliary system.

### 2 Front/entrance doors:

Push the outer edge inwards, then pivot the door into the bus.



### 3 Rear Emergency Exit:

From outside: Pull the handle and pull the door open

From inside: Pull the handle and push the door open

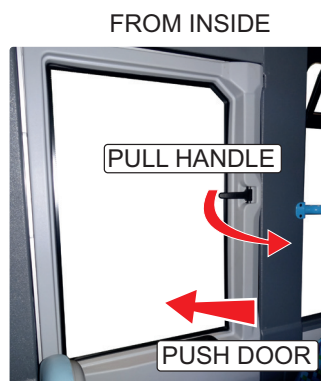

## 4. Access to the Occupants

### Driver's Cab Door.

To open the driver's door, where possible, reach in and lift the handle to release the door. Where this is impractical or not available, it may be necessary to insert a T-key into the hole on the outside of the cab door and twist to release the door lock.



### Door Controls in Driver's Cab.

The door control switches are on the right hand side of the instrument panel.

The buttons are not operative if:

- The vehicle is switched off.
- The vehicle is moving.
- The park brake is OFF.
- The system air pressure is too low.

Press the lower switch to open the doors.  
Press the upper switch to close the doors.  
The switch will flash during opening and closing and remain illuminated while the door is open.

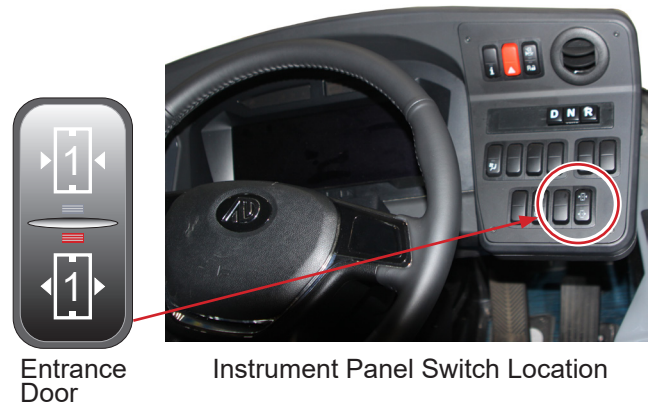

Entrance Door

Instrument Panel Switch Location

### Steering Column Adjustment.

The vehicle is fitted with an air adjustable steering column. The foot operated column adjustment switch is mounted in the floor plate directly behind the column.

To adjust the column position, the park brake must be applied. Grasp the steering wheel and depress the foot button, move the steering wheel as required for either driving or access.

If there is no air in the system, the adjustment mechanism will not release.

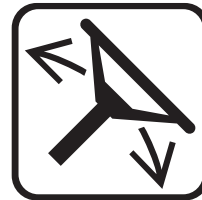

### Break Glass Escape windows.



Window break glass buttons are located around the saloon.

The saloon has buttons in 3 locations.

Twist and remove the yellow seal and strike the red button to cause the window to shatter (safety glass) to assist in an emergency exit from inside the vehicle.

The breakable windows are identified from outside the vehicle by the visible break glass sticker in the top of each breakable window. Rescue personnel may break these windows when required to gain access to the interior of the vehicle.



## 5. Stored Energy

### REESS Detail (Rechargeable Electrical Energy Storage System).

The vehicle is fitted with 11 re-chargeable battery packs with a combined storage capacity of 475.5KWh. The nominal voltage in the HV system is up to 750VDC. There are 3 types of battery pack (BP) fitted: K-Type, L-Type and O-Type. All HV BPs are NMC lithium-ion type batteries.

The battery assembly cover should never be breached or removed under any circumstances, including fire. Doing so might result in severe electrical burns, shocks, or electrocution.

#### Battery General Information:

- Under normal conditions of use, the battery does not present any risk of exposure to its content
- Exposure to high voltage (voltage higher than 60V) may be a risk if the battery casing or HV cables are breached or damaged during a collision or subsequent rescue & recovery.
- Exposure to Material / Electrolyte mixture may be a risk if the battery casing is breached
- Always contact medical assistance in the event of exposure to Material / Electrolyte mixture or High Voltage

All the battery packs are liquid cooled. The BTMS (Battery Thermal Management System), traction cooling and the cabin heater & cooling unit use an ethylene-glycol based coolant. This is supplied by Valvoline, under the name "OEM Advantage 48". Full SDS details are in the appendix. After the bus has been running, the coolant will be hot and under pressure. Do not open any caps or breach any hoses, as this poses a risk of scalding liquid or steam being released.

For full details of battery packs fitted, see the SDS in the appendix.

## HIGH VOLTAGE BATTERY LAYOUT

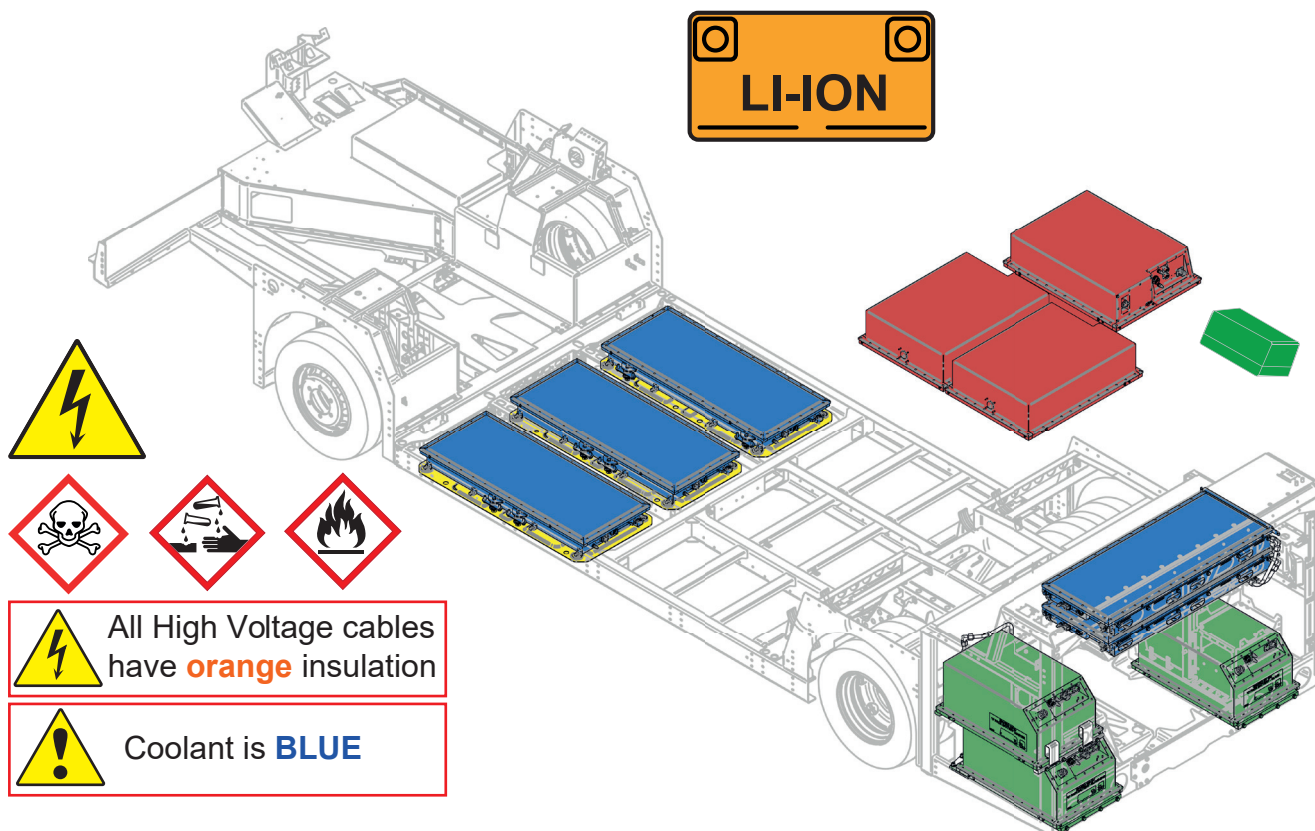

#### Thermal Runaway.

There may be risk of re-ignition for up to 48 hours after a fire has occurred. The vehicle should be quarantined and monitored for at least this time to ensure there is no further risk of fire.

C02, metal fire-ex powder or dry powder extinguisher are recommended by the battery manufacturer. Do not use water to extinguish a battery fire. Check local regulations and alert the local fire service if necessary.

## 5. Stored Energy

### HV Battery information:



### Summary of Danger

Warning, do not open or remove, do not expose to flame or open fire. Do not mix batteries with different models, different chemical properties or different types. There is a danger of explosions and burns under the conditions of fire. Do not short-circuit, squeeze, burn or disassemble the battery.

### Classification of the substance or mixture [REGULATION (EC) No 1272/2008]



Flam. Liq. 3:	H226 Flammable liquid and vapour.
Skin Corr. 1:	H314 Causes severe skin burns and eye damage.
Eye Dam. 1:	H318 Causes serious eye damage.
Acute Tox. 4:	H302 Harmful if swallowed.
STOT RE 1:	H372 Causes damage to organs through prolonged or repeated exposure.
Aquatic Chronic 3:	H412 Harmful to aquatic life with long lasting effects.
Skin Sens. 1:	H317 May cause an allergic skin reaction.

In case of electrolyte leakage from the battery:

Irritation: Irritating to eyes and skin

### General First Aid Actions

Apply existing general rules concerning first aid.

Especially, observe the following guidelines:

- Move the injured to a safe place (at least 50 meters from the dangerous area) in the fresh air.
- Perform cardiopulmonary resuscitation (CPR) if the victim is not breathing.
- Call emergency medical service

### Electrolyte Exposure Actions:

- Consult a doctor immediately.
- Where safe to do so, move the victim into fresh air and keep them calm.
- Remove and isolate contaminated clothing and shoes (of the injured and your own).
- In case of skin contact with electrolyte, immediately flush skin with lukewarm water (with dishwashing soap or soap if available) until medical help arrives; flush eyes with running water until medical help arrives. Consult a doctor if skin irritation persists.
- In case of eye contact with electrolyte rinse continuously with water for at least 10 minutes. Remove contact lenses, if present and easy to do. Continue rinsing. Shield unaffected eye. If eye irritation persists get medical advice/attention.
- In case of electrolyte swallowing do NOT induce vomiting. Swallowing may cause gastrointestinal tract burns, nausea, and vomiting.
- After inhalation of vapour or swallowing of electrolyte seek medical help immediately.
- Inform medical personnel of substances and materials involved to ensure appropriate precautions are taken.

### Electric Shock.

Personnel who have been exposed to an electric shock should be checked for internal injuries even if they have no visible or obvious symptoms.

### Environmental Precautions.

Do not discharge leakages into the drains/surface waters/groundwater, where possible and safe, prevent any fluid escape from entering surrounding watercourses. Absorb the substance with an absorbing agent such as earth, sand or other non-combustible, non-conductive material and dispose of it in a glass container or plastic bag.

Dispose of absorbed material in accordance with local regulations.

Fire residues and contaminated firefighting water must be disposed of in accordance with the local regulations

This is a summary, for a full list of safety information, precautions and actions, please refer to the SDS in the appendix



## 5. Stored Energy

### Compressed Air.

# AIR

The vehicle uses compressed air for braking, suspension and assorted accessory tasks.

Air is supplied by a High-Voltage air compressor, through a drier and is stored in steel reservoirs distributed around the vehicle.

The air looms are made from PVC which is not fire-resistant and will deform and fail in the event of a fire, possibly resulting in the loss of air pressure.

The Air system runs at a maximum pressure of 10Bar / 130PSIG.

The rear-mounted compressor is connected to the HV system and will run on demand all the time the bus is turned on

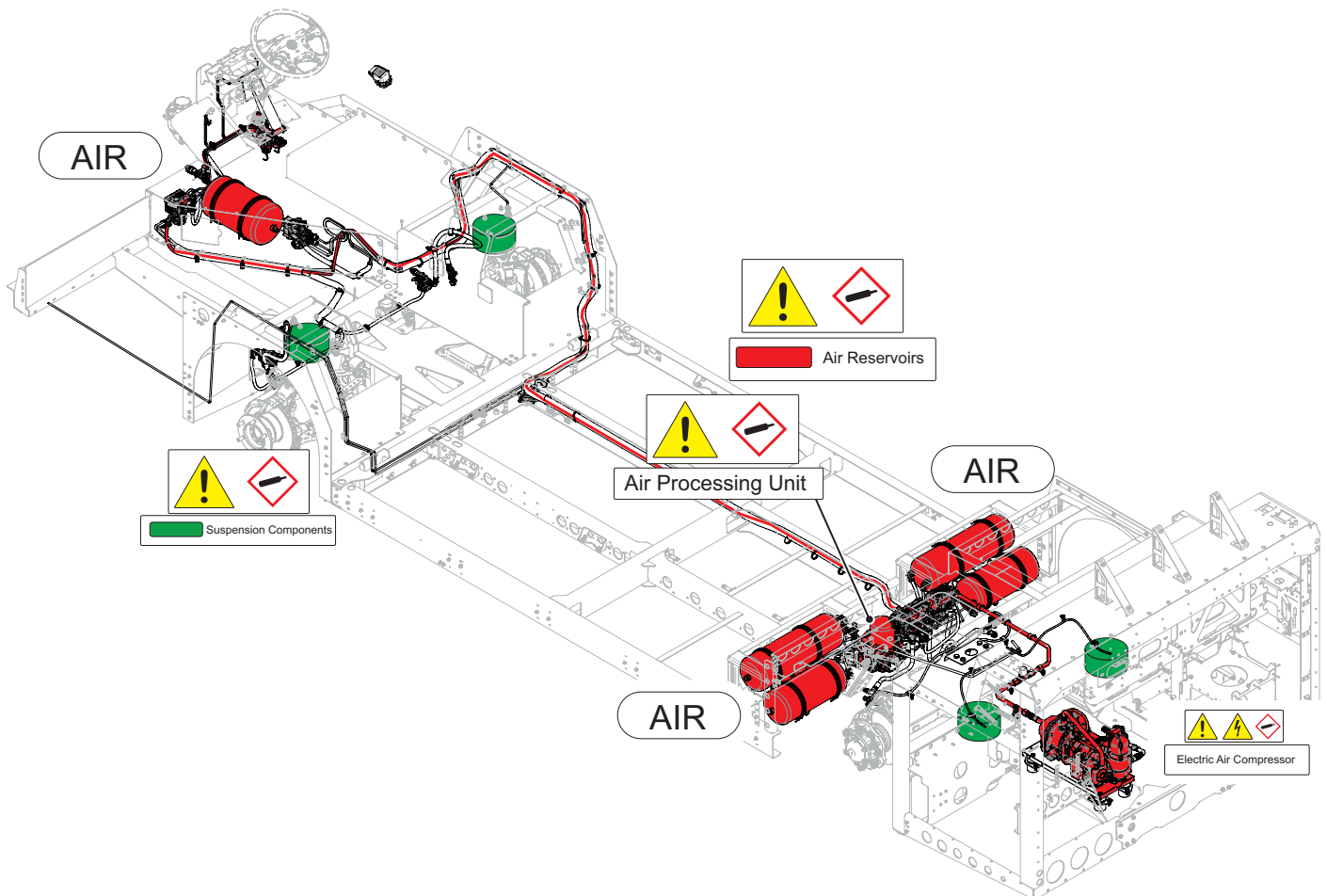

### Power Steering.

The vehicle is equipped with an electro-hydraulic power steering system. There is a HV pump below the driver's foot plate and a hydraulic reservoir mounted at the front of the vehicle.

In the event of a front impact, the hydraulic fluid may escape if the system is ruptured.

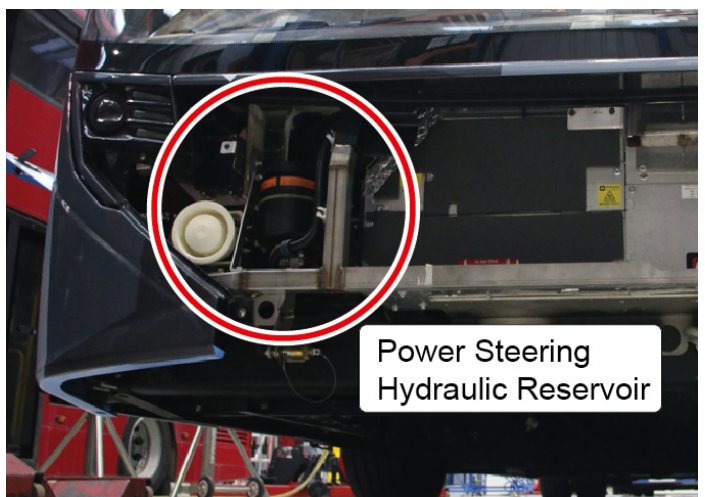

## 5. Stored Energy

### Air-conditioning Refrigerant Systems

There are several system components around the vehicle

BTMS - Battery thermal Management System plus Traction and other Drive Systems Cooling is carried out on the roof of the vehicle in a self-contained pod.

Driver and Cabin air-cooling is provided from a unit mounted at the front of the vehicle, below the windscreen, with a refrigerant line running from the pod, along the driver's side roof and down behind the driver's seat, then from there to the front demister.

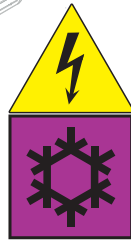
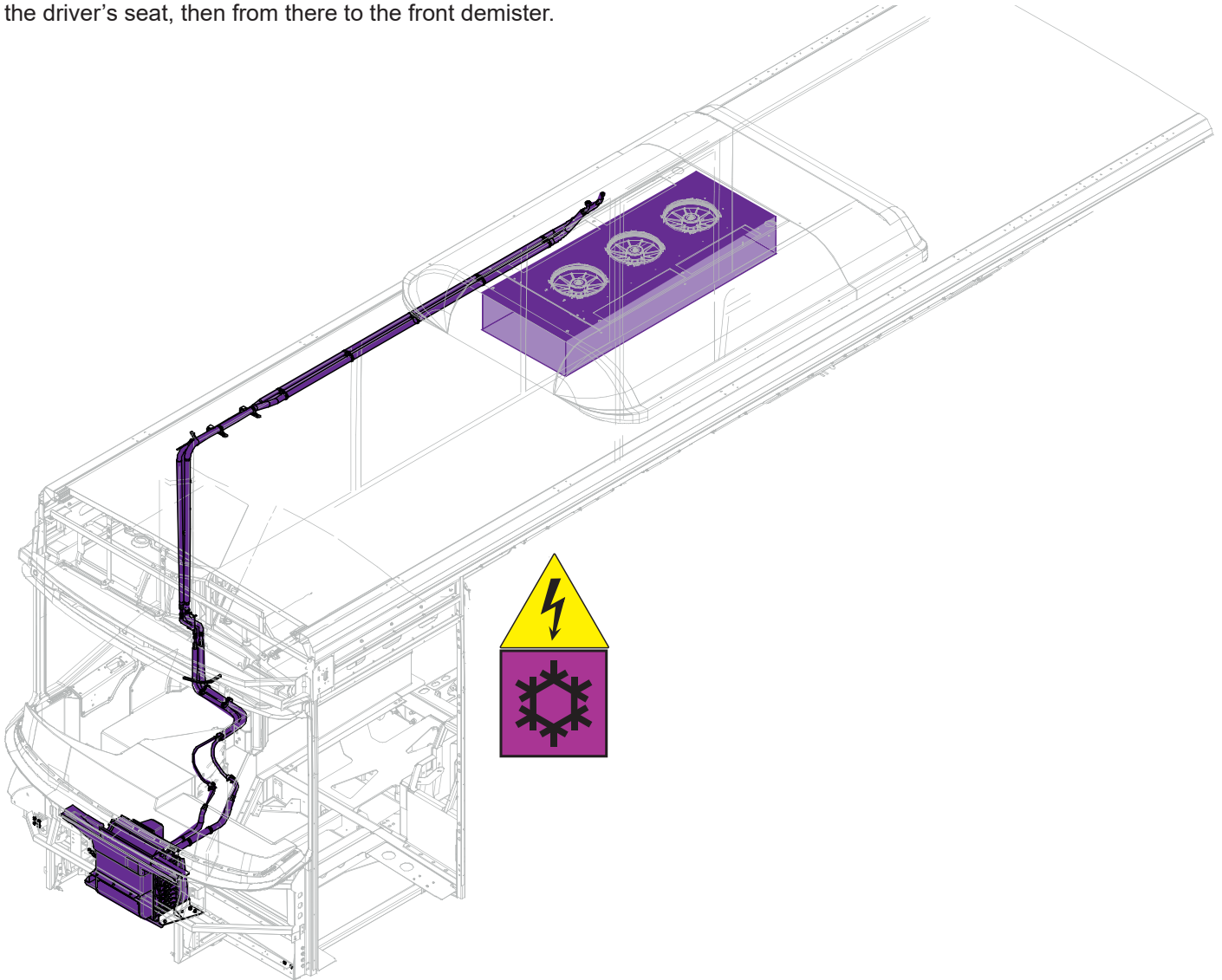

There is a compressed refrigerant present within the BTMS and the heating & cooling system.



R407C Refrigerant

H280 - Contains gas under pressure; may explode if heated

Caution: Contact with liquid or refrigerated gas can cause cold burns and frostbite

Please see the SDS in the appendix for full material details on the gas and fluids within these units.

The BTMS, traction cooling and the cabin heater & cooling unit use an ethylene-glycol based coolant. This is supplied by Valvoline, under the name "OEM Advantage 48". Full SDS details are in the appendix.



ETHYLENE GLYCOL

H302 - Harmful if swallowed.

H373 - May cause damage to organs (Kidney, Liver) through prolonged or repeated exposure if swallowed.

## 6. In Case of Fire

Do not submerge to extinguish fire



**DO NOT SPRAY WATER DIRECTLY INTO THE DRIVE BAY.**

### Battery Product identification:

NMC lithium-ion battery pack

Chemical Class: ADR Class 9 – miscellaneous dangerous goods.

**DO NOT USE WATER ON Li-Ion BATTERY FIRES:**

CO<sub>2</sub>, metal fire-ex powder or dry powder fire extinguishers are acceptable.

WARNING: Do not submerge vehicle to extinguish fire.

**Battery Re-Ignition:** Where a battery fire is experienced or suspected, monitor for at least 48 hours with thermal fire detection equipment, quarantine vehicle where necessary.

### Drive Bay Fire Warning Light.

This dashboard light illuminates when one or more rear drive bay fire sensors or system is triggered.



### Hand-held Fire Extinguisher.

There is a hand-operated dry powder fire extinguisher mounted behind the driver in the cab.

This can be used to assist safe exit of passengers from the bus in the event of an internal fire.



## 6. In Case of Fire

### Battery Pack Access From Outside The Bus.

When monitoring the vehicle with thermal imaging equipment, these are the areas most likely to be at risk from any HV battery issues



The hashed areas highlight where a thermal imaging monitor may be able to detect an overheating battery.

The floor of the bus has battery packs within the structure.

The rear drive bay has batteries within the frame of the bus.

There are batteries mounted on the roof of the bus in a self-contained pod.



Left hand rear side battery locations



Rear drive bay battery locations

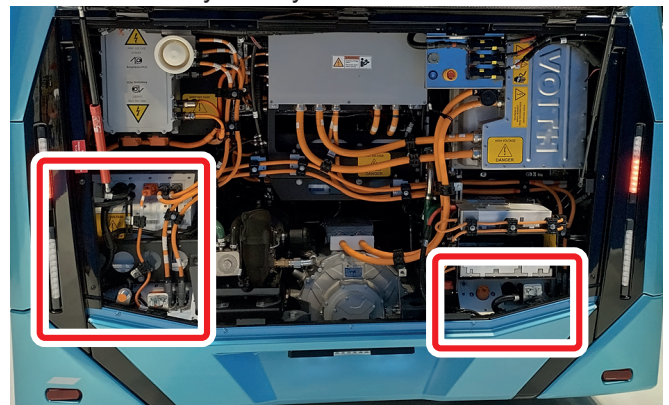

## 6. In Case of Fire

### Fire where batteries are NOT damaged.

Recommendations for extinguishing an electric vehicle fire:

- Secure the surroundings (prevent access to the fire by outsiders).
- Keep a suitable distance from the fire, pay attention to the wind direction and do not approach “upwind”.
- Extinguish the vehicle with water or foam.

Recommendations for extinguishing traction batteries with non-damaged casings:

- Extinguish with plenty of water (fire takes a long time to extinguish).
- Extinguish from a distance of at least 1 metre from the battery.
- Do not open or break the battery casing.
- Check the fire with a thermal imaging camera.

### WARNING.

If using water to extinguish/suppress an HV battery, use a large volume of water. Using only a small amount could allow dangerous toxic gases to be released. If a Lithium Ion HV battery is involved in a fire, there is a possibility that it could reignite after extinguishing. If available, use thermal imaging to monitor the battery. Do not store a vehicle containing a damaged or burned Li-Ion HV battery in or within 50 feet of a structure or other vehicle until the battery can be discharged. Re-ignition of fire in an HV battery pack is typically accompanied by “whooshing” or “popping” sounds, followed by off-gassing of white smoke and/or electrical arcs/sparks that reignited with visible flames/fire. Re-ignition can occur again.

### NOTE.

Because HV batteries are in protective cases, it is very difficult to get any extinguishing agent directly onto the burning cells. The application of large volumes of water may cool the HV battery case sufficiently to prevent the propagation of fire to adjacent cells. Continuous application of water on a localized area of the battery for a prolonged period before moving to another section of the battery provides for quicker extinguishing. Continue to apply water even after the visible flame is no longer present to properly cool the HV battery pack and prevent/reduce the risk of re-ignition. Anticipate longer fire suppression times once the HV battery is involved due to the difficulty in accessing the burning material inside the battery case.

### Event of battery fire where battery case is, or may be, damaged.

#### Extinguishing media

Follow local fire protection regulations. CO<sub>2</sub>, metal fire-ex powder or dry powder extinguisher are recommended by the battery manufacturer. When the battery is on fire then water is allowed only for cooling the casing of the battery. When the battery is open and cells are visible, water is FORBIDDEN. Non-water extinguishing media only to be used directly on the cells.

#### Special hazards arising from the substance or mixture

Hazardous combustion products: carbon monoxide, carbon dioxide, lithium oxide fumes.

Fire as the result of collision/ road accident/ severe impact

- In case of severe impact/shock (even when there is no visible damage) inform the fire brigade immediately; give information about the vehicle- state clearly that the vehicle is electric, inform about the type of potential fire and burning substance - chemistry inside battery cells; the short circuit is possible due to broken battery insulation even after vehicle power shut off.
- Do not extinguish battery fire. The risk of toxic vapour inhalation and severe burns is too high.
- Remain at the disposal of the fire brigade when they arrive.

## 6. In Case of Fire

### Fire in a storage area

- Storage area should be prepared and equipped according to the local fire prevention inspector's prescription in compliance with effective local laws. The area is recommended to have CO<sub>2</sub>, metal fire-ex powder or dry powder fire extinguishers (2 pieces, capacity – 6 kg), personal protective equipment: respirators, and dielectric insulating gloves.
- Battery fire danger is not recognized only by sparks and flames. Other potential fire symptoms are leaking fluids, increased temperature, and disturbing sounds such as bubbling or gurgling inside the battery.
- Remain upwind of the fire.
- Call for medical help and provide first aid to the injured.
- Call the fire brigade and inform them about the accident; give them information about the vehicle- state clearly that the vehicle contains lithium-ion batteries, inform them about the type of fire and burning substance - chemistry inside battery cells.
- Remain at the disposal of the fire brigade when they arrive.
- Do not extinguish battery fire yourself unless you have specialised equipment and attended the training. The risk of toxic vapour inhalation and severe burns is too high.
- To minimise damage to company goods and property before the fire brigade arrives, use personal protective equipment when extinguishing the fire (as prescribed by local fire prevention inspector, where applicable).
- Prevent the inhalation of toxic gas and carry out extinguishing actions from windward.
- The fire should be extinguished by the fire brigade with suitable extinguishing media.

### Fire during charging

- Battery fire danger is not only recognized by sparks and flames, but potential fire symptoms are leaking fluids, increased temperature, and bubbling or gurgling sounds inside the battery.
- If it is safe to disconnect power from the battery (disconnect from the grid/ disable current flow in the battery) – use an emergency power disconnect switch in the building/ area.
- Remain upwind of the fire.
- Call for medical help and provide first aid to the injured.
- Call the fire brigade and inform them about the accident; give them information about the vehicle- state clearly that the vehicle is electric, inform them about the type of fire and burning substance - chemistry inside battery cells.
- Remain at the disposal of the fire brigade when they arrive.
- Do not extinguish battery fire yourself unless you have specialized equipment and attended the training. The risk of toxic vapour inhalation and severe burns is too high.
- To minimise damage to company goods and property before the fire brigade arrives use prescribed by local fire prevention inspector personal protective equipment when extinguishing a fire. Prevent the inhalation of toxic gas and carry out extinguishing actions from windward.
- The fire should be extinguished by the fire brigade with suitable extinguishing media.

#### Additional advice for firefighters

- Use self-contained breathing apparatus.
- Wear a fully protective suit.
- Cool unbroken containers at risk with a water spray jet.
- Fire residues and contaminated firefighting water must be disposed of in accordance with local regulations.

### Storage of damaged batteries

After the accident, immediately isolate the battery in a safe place. If the battery starts to emit an unusual smell, develop heat, change shape/geometry, emit disturbing sounds, or behave abnormally it may indicate a problem.

In this case, the battery must be given special attention. Additionally, damaged batteries must be stored in a well-ventilated area and protected from third-party access. They must be separated from other batteries. If there is a fire hazard involved, inform the fire brigade and the manufacturer immediately. The storage area must be equipped with a fire extinguisher applicable to this battery. For safety reasons damaged batteries/cells should not be stored at the user's facilities. They should be disposed of in compliance with applicable regulations. It is also recommend storing the battery after the fire in a special crate in a quarantine zone.

## 7. In case of Submersion

### Floodwater or Fording.

Maximum wading depth under normal usage should not exceed 32cm.

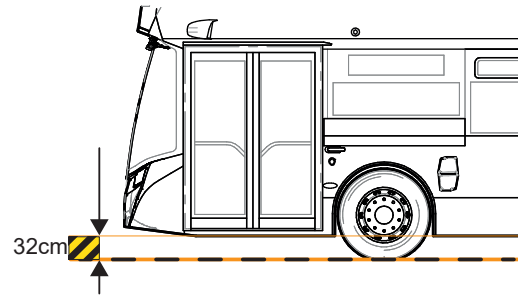

### Deeper Immersion. (Depths greater than 33cm)

If the depth of water exceeds 33cm or is unable to be determined, seek an alternative route.

Travel in deeper water can cause damage to critical systems including, but not limited to, HV systems, and could lead to dangerous exposure to high voltages as well as causing breakdowns.

If the vehicle has been fully immersed in water for longer periods, contact Alexander Dennis for details on how to deal with the battery packs.

In the event of submersion (water is above the entrance ramp or over the rear bumper), proper PPE gear with a minimum arc flash rating of 8cal/cm<sup>2</sup> is required before approaching the rear of the vehicle.

If the REESS is submerged or partially submerged, a voltage hazard exists at the batteries and may exist between HV energized components. Avoid contact with HV components, cabling, or service disconnects on a submerged vehicle.

The front and sides of the vehicle do not pose a HV risk if partially submerged.

The vehicle should be retrieved from the water before other work is performed. Water levels below the bottom of the vehicle (less than 30cm) should not pose any HV risk.

1. Assess vehicle for risks.
2. Shutdown the vehicle by pushing the emergency stop switch on the driver's side console to the STOP position. (See page 7)
3. If accessible and where fitted, turn OFF the 24 VDC Battery Disconnect switch, located behind the battery access door below the driver's cab. (See page 8)
4. Avoid contact with High Voltage (HV) components.
5. Attend to any first aid needs.
6. Access to passengers can be gained through the entrance and exit doors, or side windows.



### **⚠ DANGER**

High Voltage Cables are routed within the rear compartment and under the vehicle. If these cables become damaged or exposed during an accident, they may remain live. Ensure the High Voltage system is disabled using the High Voltage Interlock switch, after recovering the vehicle from the water, before working in the area of damaged cables.

### Storage following immersion:

The vehicle should be stored in a safe, covered location.

The bus should be locked out to prevent it being powered-up until all systems have been checked and certified safe to use by a qualified and approved engineer.

All water should be allowed to drain away and the vehicle dried thoroughly before any attempt is made to restore power to any system.

## 8. Towing / Transportation / Storage

When towing the vehicle, always follow the correct towing procedure as detailed below.

### When towing, the following functions are not available:

1. Power assisted steering
2. Compressed air supply
3. Recharging of the 24Volt vehicle battery

1: Press the lower part of the ignition switch to turn off the bus. Switch will flash.

2: Press and release the master switch to turn off the main power. Switch will flash while the bus shuts down.



### Preparations before towing the vehicle

1. Select neutral gear and apply the parking brake.
2. Remove both half-shafts (see over for details).
3. Attach vehicle to tow truck.
4. Release the parking brake.
5. Turn off the ignition and master switches to power-off the bus.
6. Where applicable, turn off the 24V battery disconnect switch within the front battery compartment.
7. Disconnect the HV system by removing the **Manual Service Disconnect (MSD)** plugs at the rear.
8. Vehicle tow can now proceed.

**Always keep road speed as low as possible and do not exceed 25MPH maximum speed at any time.**

To access the **Manual Service Disconnect** plugs in the High Voltage Junction Box, open the rear drive bay door.

**WARNING:** Do not disturb the MSD plugs if the vehicle is on charge. Stop and remove charge supply before touching. Failure to do so may result in danger to life or damage to equipment.

### On both MSD plugs:

Release the locking tabs before lifting the lever to 90°. Pull the plugs out of the High Voltage Junction Box. Store the MSD plugs safely inside the bus.

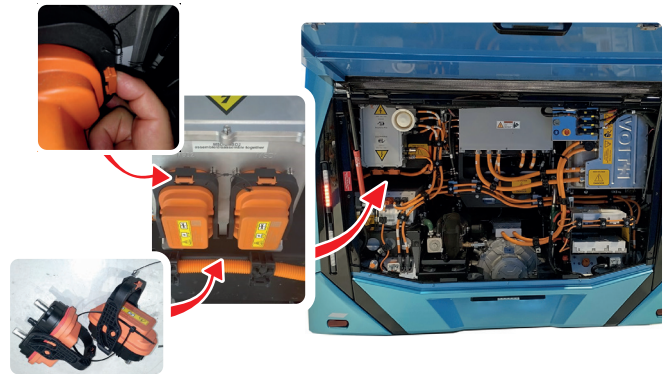

## Accessing Towing Connections

To access the towing eye socket and compressed air charge coupling, open and remove the front panel. Store the panel safely inside the bus.

The towing eye should be screwed into the tapped socket in the front crossmember.

An air coupling is located on the front of the vehicle to provide air to the braking system during the tow.



Open and lift panel out and away from the clips

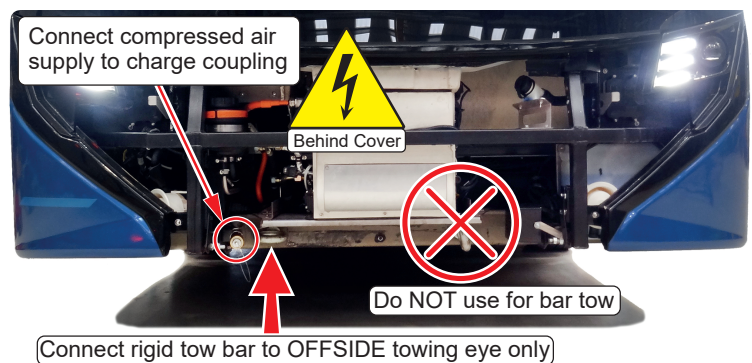
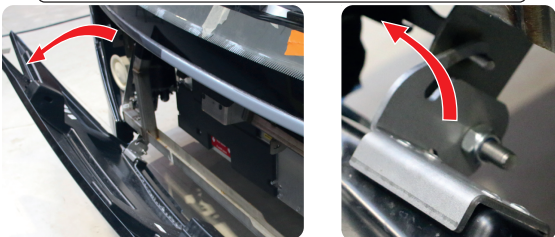

**For rigid bar towing only the OFFSIDE eye must be used, as indicated, to prevent damage to the front components.**

**The vehicle may be towed using both front towing points and an A-Frame. The vehicle may also be recovered by a lifted or suspended front end tow.**



## 8. Towing / Transportation / Storage

### ⚠️WARNING:

In this condition the parking brakes are completely inoperative. Wheels **MUST** be chocked to prevent the vehicle from rolling.

The electronic parking brake will NOT be disengaged with an external air supply to the air charge point, so manual release of the spring brake actuators will be necessary

Access to the drive axle actuators is via an access panel on the floor between the rear seats over the rear axle. Use an allen wrench to remove the panel. This gives access to the top of the brake actuators.

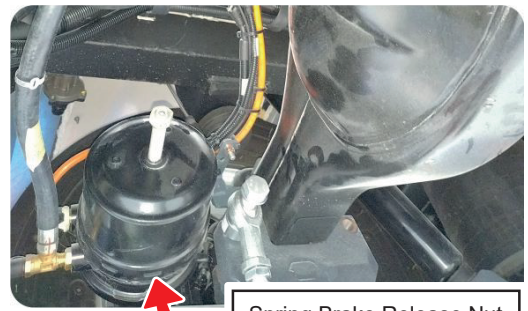
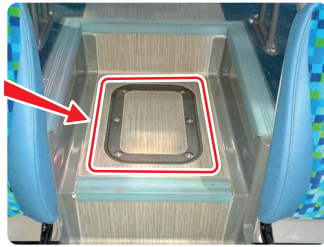

Spring Brake Release Nut

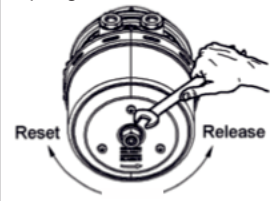

Use a 24mm spanner to wind the actuators off to release the brakes.

When the vehicle is towed, the rear half-shafts must be removed to prevent damage to the axle or drive motor.

Alternatively the propshaft may be removed or the rear axle lifted off the road

### Removing drive axle half-shafts

#### ⚠️WARNING:

Proper consideration must be given to traffic conditions and the danger from passing traffic fully assessed and any necessary precautions taken before attempting to remove half shafts.

When towing, both axle half-shafts **MUST** be removed to prevent any damage to the axle or drive motor.

When half-shafts are removed, the open axle ends must be temporarily plugged to prevent loss of oil.

The removed shafts should be stored safely inside the bus.

For towing purposes, there is no need to remove the wheels.

Loosen screws on the flange shaft and pull out the half shaft.

Be prepared to catch any outfall of oil from the axle during this process.

**Note:** When the half shafts are removed, plug or cover both hubs.

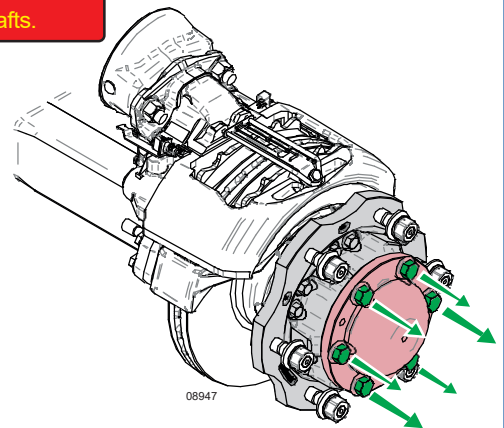

### Suspended Towing

When carrying out a suspended tow in reverse, it is important to lock the steering in the "straight-ahead" position to prevent uncontrolled movement of the steering gear and front axle steering components.

The vehicle should be not be lifted beyond the figures given when using a suspended tow;

Front lift angle not to exceed 7.8°

Rear lift angle not to exceed 9°

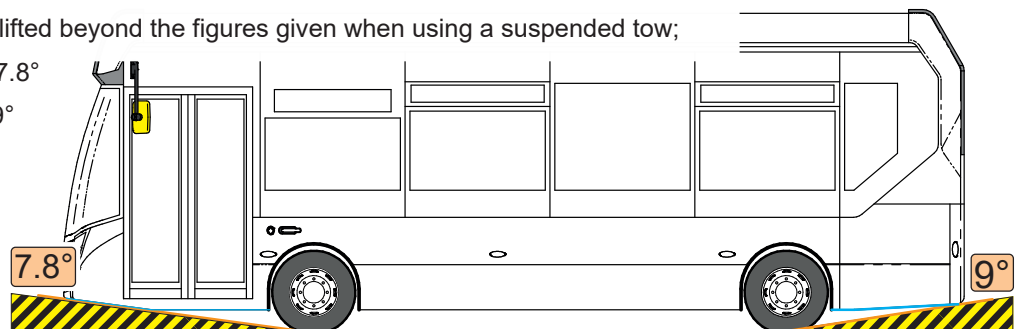

### After Towing

#### ⚠️WARNING:

When the tow procedure is complete, the parking brakes must be wound back on or the wheels chocked to prevent the bus from rolling away.

See the service manual for correct procedures and torques when refitting the half-shafts to the axle.

It is important to check the oil level of the axle after any towing procedure where the hubs are disturbed.

## 8. Towing / Transportation / Storage

### Vehicle Storage.

When storing the vehicle following a fire or crash follow the below instructions.

#### Procedure following a fire:

The vehicle should be quarantined in a safe, covered location, away from other vehicles.

Monitor the battery areas with thermal equipment for up to 48 hours to ensure there is no spontaneous reignition

All HV systems should remain disconnected and locked off until fully inspected by a qualified and approved engineer.

Any powder residue should be cleaned off to prevent any corrosion or other issues.

If water has been used to fight any fire, all affected systems must be thoroughly dried before any power is turned on.



#### Procedure following immersion in water: (See also: Section 7)

The vehicle should be stored in a safe, covered location.

Do not power-up the bus until all systems have been checked and certified safe to use by a qualified and approved engineer.

All water should be allowed to drain away and the vehicle dried thoroughly before any attempt is made to restore power to any system.

---

### Suspended tow:

The vehicle should not be lifted beyond the figures shown below when using a suspended tow;

Front lift angle not to exceed 7.8°

Rear lift angle not to exceed 9°

When carrying out a suspended tow in reverse, it is important to lock the steering in the “straight-ahead” position to prevent uncontrolled movement of the steering gear and front axle steering components.

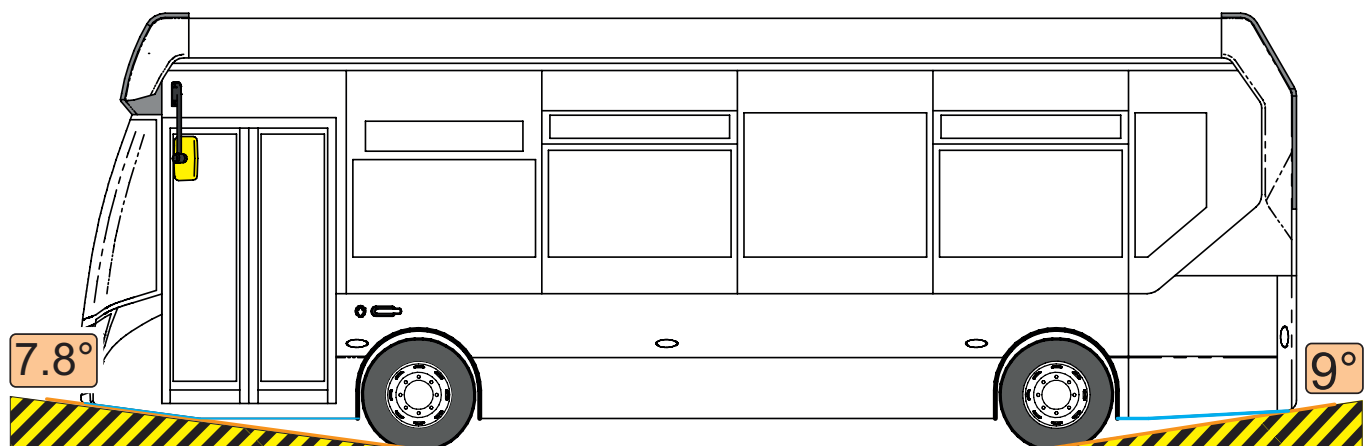

## 8. Towing / Transportation / Storage

When storing the vehicle, always follow the correct storage disconnection procedure as detailed below.

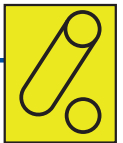

### Shutdown Procedure

**ALWAYS engage the parking brake before leaving the cab.**

After operation remember to:

- Select 'Neutral'
- Apply the parking brake.

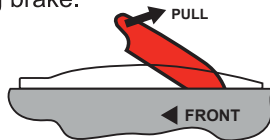

Turning off the Bus:

- 1: Press the lower part of the ignition switch to turn off the Bus. Switch will flash.
- 2: Press and release the master switch to turn off the main power. Switch will flash and the rundown sequence begins.



### Short Term Vehicle Storage

#### 24V Battery: Disconnect and Monitor

When it is necessary to store the vehicle for longer than 48 hours it is important to make sure the correct storage procedures are followed. Follow the 24v battery disconnection procedure.

Alexander Dennis recommend regular testing of the 24v battery system in order to maintain optimum battery performance and to reduce vehicle downtime. It is recommended that an industry suitable tester be used to determine the condition of the batteries on a regular basis.

The tester must be correctly suited to the task of testing an SLI lead-acid battery with up to 230Ah and 1200A CCA.

A suggested example is the Midtronics INTELLECT EXP-1000 FHD Expandable Electronic Diagnostic Platform

### 24v Battery Disconnection

**⚠ WARNING: DO NOT disconnect the batteries while the bus is running.**

Battery access is via an access door at the front, below the driver's cab.

Lift and secure the access door, release the antiluce fasteners, then slide the tray out to access the battery connectors and remove the negative connection. Secure cable to prevent accidental re-connection.

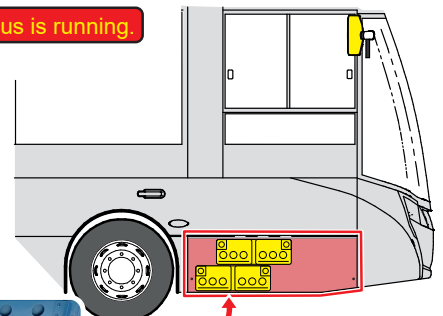

Battery negative cable disconnected and secured

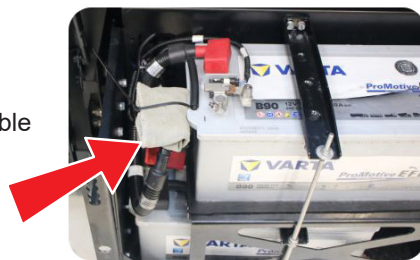

### Longer Term Vehicle Storage

#### Traction Battery: Monitor SOC

Where the storage period is likely to exceed 30 days, in addition to the 24v monitoring, the HV batteries will also require checking as follows:

The vehicle should be stored with a traction battery SOC of 40% ( $\pm 10\%$ ) at the start of the storage period. Li-Ion self-discharge is at around 4% per month, therefore charge level must be monitored over time and batteries charged if required.

Optimum temperature for storage is between 0°C and +25°C.

Humidity should not exceed 80%.

Before returning to service use, the batteries should be charged to 100% SOC

SOC Gauge

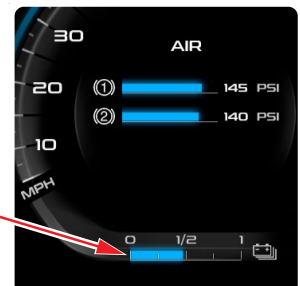

#### Safety Notes

Do not store vehicle if any battery pack is damaged, this must be investigated and rectified immediately.

Storage area should be equipped with fire extinguisher (CO2 or Dry Powder type)

## 9. Important Additional Information

### Rear Impact Detection Sensor.

#### Following a collision:

In the case of a rear impact, the vehicle has a rear-mounted impact sensor that is triggered by excess G-forces.

The vehicle will not turn on and will display “Emergency Shutdown Active” symbol on the dashboard



The vehicle will display “Rear Impact Detection Sensor” symbol on the dashboard



There may be a text display in the centre of the screen showing the shutdown is active, and the reason. Use the I-Button to scroll through the messages.

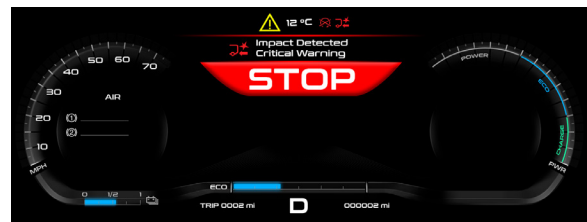
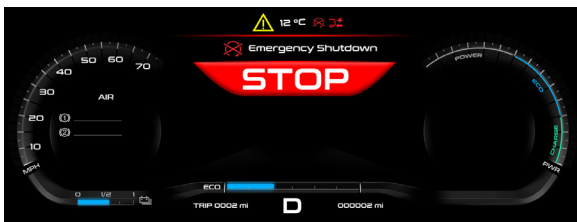

The Rear impact sensor must be reset before the vehicle will turn on.

It is important to ensure there is no damage to any of the HV systems before the sensor is reset in order to prevent any accidental exposure of personnel to high voltages.

The sensor is located at the rear of the vehicle, inside the drive bay.

Access to reset the switch is via the rear drive bay door.

**CAUTION:** Do not attempt to access this area if there is any damage to any part of the HV system in the drive bay. Damaged insulation or HV components may present an electrocution risk.

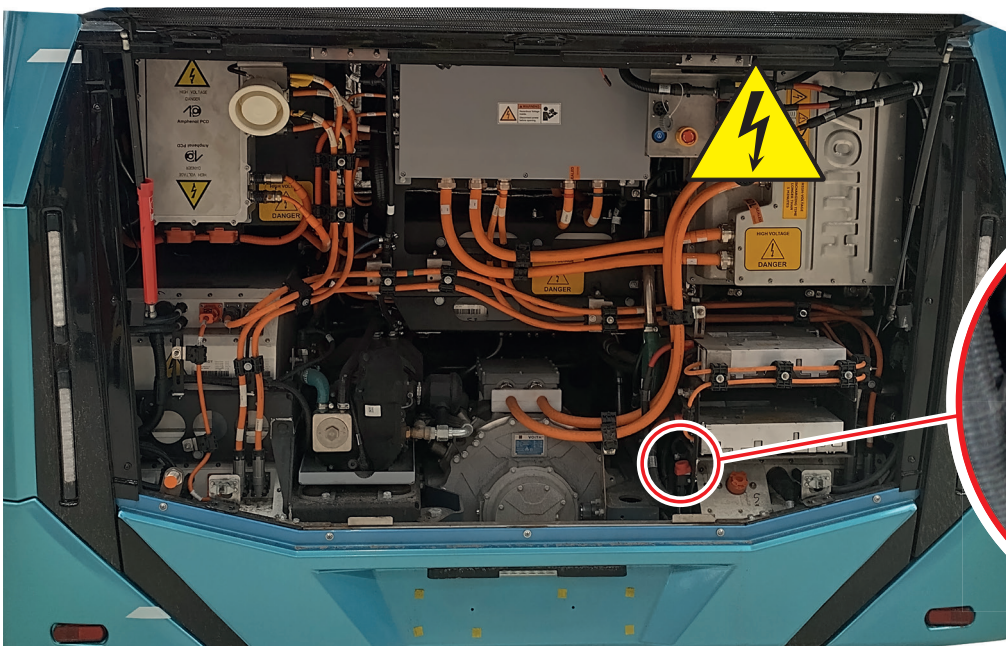

To reset the crash sensor, push the button on the top of the unit.

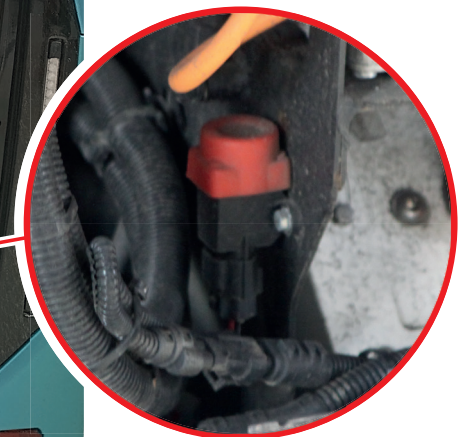

## 10. Explanation of Pictograms Used

### 1. Propulsion Identification



Li-Ion / NMC Battery - Electric bus

Model designation display not guaranteed.

### 2. Immobilisation / stabilisation / lifting

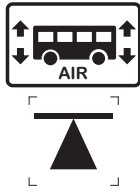

Suspension controls in driver's switch area.

Safe lifting points.

### 3. Disable direct hazards / safety regulations



Disconnect High Voltage.



Disconnect Low Voltage.

### 4. Access to the occupants



Door access control - two exit doors.



Five break glass exits in upper saloon, three in lower saloon.



Steering wheel control on driver's footplate.

### 5. Stored energy

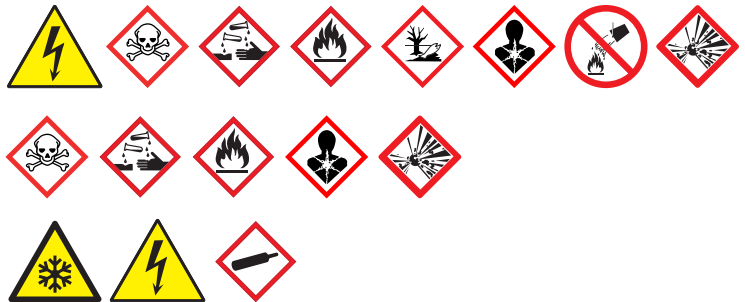
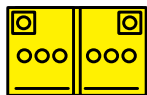

### 6. In case of fire



### 7. In case of submersion



As for [Section 3: Disable Direct Hazards](#)

Follow all recommended safety routines once out of the water.

### 8. Towing / transportation / storage



Disconnect High Voltage.



Disconnect Low Voltage.

<b>Extra information.</b>
---------------------------

The appendix to this document contains extra information (as Safety Data Sheets) as follows:

1. HV Battery pack info
2. Valvoline coolant (Valvoline OEM ADV48)
3. R407C refrigerant (BOC gasses)
4. Hydraulic steering oil (Fuchs Titan ATF 4000)
5. Flooded Lead acid 12V battery (Varta)





This document covers only those models listed on the front cover. It should be regarded as part of the product and retained with the vehicle. At the time of resale it should be passed on to any subsequent owner. Where the manual lists the specifications for several models, some of the items covered may not apply to your vehicle.

If any doubt exists please do not hesitate to contact Alexander Dennis who will be pleased to offer technical assistance.

We would like to point out that non-Alexander Dennis parts have not been approved by Alexander Dennis and we cannot certify the suitability nor the safety of such parts. Alexander Dennis is not liable for any damage caused by the use of non-Alexander Dennis parts.

All rights reserved. No part of this publication may be reproduced, stored in a retrieval system, or transmitted, in any form or by any means, electronic, mechanical, photocopying, recording or otherwise without prior written permission of Alexander Dennis.



**SDS information**

- 1. HV Battery pack info .....Page 3 - 25
- 2. Valvoline coolant (Valvoline OEM ADV48).....Page 27 - 36
- 3. R407C refrigerant (BOC gasses).....Page 39 - 56
- 4. Hydraulic steering oil (Fuchs Titan ATF 4000) .....Page 59 - 81
- 5. Flooded Lead acid 12V battery (Varta) .....Page 83 - 93





## Material Safety Data Sheet 640-257

<b>Document type / Typ dokumentu</b>	MSDS
<b>Project / Projekt</b>	640-257
<b>Device version / Wersja sprzętu</b>	K – all variants
<b>Contact person / Osoba kontaktowa</b>	Szymon Majewski
<b>E-mail address / Adres e-mail</b>	szymonmajewski@icpt.pl
<b>Telephone number / Numer telefonu</b>	+48 22 758 68 65
<b>Support / Wsparcie techniczne</b>	<a href="mailto:support@icpt.pl">support@icpt.pl</a>

<b>Applicable battery variants</b>	<b>Part numer</b>
K Master	640-257-A-*
K Slave	640-257-B-*
K Slave-end	640-257-E-*

\* - any following character

<b>Modification log / Rejestr modyfikacji</b>			
<b>Version / Wersja</b>	<b>Description / Opis</b>	<b>Author / Autor</b>	<b>Approved by / Zatwierdził</b>
v_0_01	- material safety data sheet of battery pack	Szymon Majewski	Jeżeli to pole jest puste to dokument powinien być traktowany jako NIEZATWIERDZONY. If this field is empty then document should be considered as NOT APPROVED.

## Table of contents

1.	Chemical product and company identification .....	5
1.1.	Product identifier .....	5
1.2.	Relevant identified uses of the substance or mixture and uses advised against.....	5
1.2.1.	Relevant uses.....	5
1.2.2.	Uses advised against.....	5
1.3.	Details of the supplier of the material data sheet .....	5
1.4.	Emergency telephone number .....	5
2.	Hazard identification .....	6
2.1.	Summary of danger .....	6
2.2.	Classification of the substance or mixture [REGULATION (EC) No 1272/2008] .....	6
2.3.	Label elements .....	6
2.4.	Other hazards .....	7
3.	Composition/information on ingredients .....	7
4.	First – aid measures.....	8
4.1.	Description of first aid measures .....	8
4.2.	Most important symptoms and effects, both acute and delayed.....	9
4.3.	Indication of any immediate medical attention and special treatment needed .....	9
5.	Fire – fighting measures .....	10
5.1.	Extinguishing media .....	10
5.2.	Special hazards arising from the substance or mixture .....	10
5.3.	Advice for firefighters.....	10
	<b>Fire fighting procedures for user:</b> .....	10
6.	Accidental release measures.....	12
6.1.	Personal precautions, protective equipment and emergency procedures.....	12
6.2.	Environmental precautions .....	12
6.3.	Methods and material for containment and cleaning up .....	13
6.4.	Reference to other sections .....	13
7.	Handling and storage .....	13
7.1.	Precautions for safe handling.....	13
7.2.	Conditions for safe storage, including any incompatibilities .....	13
7.3.	Specific end use(s).....	15
8.	Exposure controls and personal protection .....	15

Exposure controls .....	15
9. Physical and chemical properties .....	16
Appearance.....	16
Odour.....	16
Odour threshold .....	16
pH .....	16
Freezing/melting point .....	16
Boiling point.....	17
Flash point .....	17
Evaporation rate .....	17
Flammability (solid, gas).....	17
Upper/lower flammability or explosive limits.....	17
Vapour pressure and reference temperature .....	17
Vapour density .....	17
Relative density .....	17
Solubility in water.....	17
Partition coefficient: n-octanol/water .....	17
Auto-ignition temperature .....	17
Decomposition temperature.....	17
Viscosity.....	17
10. Stability and reactivity .....	18
10.1. Reactivity .....	18
10.2. Chemical stability .....	18
10.3. Possibility of hazardous reactions .....	18
10.4. Conditions to avoid.....	19
10.5. Incompatible materials.....	19
10.6. Hazardous decomposition products.....	19
11. Toxicological information.....	20
11.1. Information on toxicological effects.....	20
12. Ecological information.....	20
12.1. Toxicity.....	20
12.2. Persistence and degradability .....	21
12.3. Bioaccumulative potential.....	21
12.4. Mobility in soil .....	21

12.5.	Results of PBT and vPvB assessment.....	21
12.6.	Other adverse effects .....	21
13.	Disposal considerations.....	21
13.1.	Waste treatment methods.....	21
14.	Transport information .....	21
14.1.	UN numer .....	21
14.2.	UN proper shipping name .....	22
14.3.	Transport hazard class(es).....	22
14.4.	Packing group .....	22
14.5.	Environmental hazards.....	22
14.6.	Special precautions for user .....	22
15.	Regulatory information .....	23
15.1.	Safety, health and environmental regulations/legislation specific for the substance or mixture	23
15.2.	Chemical safety assessment.....	23
16.	Other information .....	23
1.1.1	General disclaimer.....	23

## 1. Chemical product and company identification

Sections from 2 to 13 are based on information from battery modules manufacturer and relate mainly to modules, which are the most dangerous component of ICPT battery system if not used correctly or damaged. Other battery system components do not pose danger to battery users.

### 1.1. Product identifier

640-257 NMC lithium-ion battery pack

Chemical class: ADR Class 9A – miscellaneous dangerous goods

Synonym: Li-ion

### 1.2. Relevant identified uses of the substance or mixture and uses advised against

#### 1.2.1. Relevant uses

The battery system can be used only in prototype vehicles system i.e. as power supply source.

#### 1.2.2. Uses advised against

None known.

### 1.3. Details of the supplier of the material data sheet

Name	Impact Power Clean Technology S.A.
Address	ul. Świętokrzyska 30/63 00-116 Warszawa Poland
Office address	Aleje Jerozolimskie 424A 05-800 Pruszków Poland
Shipping address	ul. Jarzębinowa 12 05-800 Pruszków Poland

### 1.4. Emergency telephone number

+48 22 758 68 65

## 2. Hazard identification

### 2.1. Summary of danger

Warning, do not open or remove, do not expose to flame or open fire. Do not mix batteries with different models, different chemical properties or different types. There is a danger of explosions and burns under the conditions of fire. Do not short-circuit, squeeze, burn or disassemble the battery.

### 2.2. Classification of the substance or mixture [REGULATION (EC) No 1272/2008]

Flam. Liq. 3:	H226 Flammable liquid and vapour.
Skin Corr. 1:	H314 Causes severe skin burns and eye damage.
Eye Dam. 1:	H318 Causes serious eye damage.
Acute Tox. 4:	H302 Harmful if swallowed.
STOT RE 1:	H372 Causes damage to organs through prolonged or repeated exposure.
Aquatic Chronic 3:	H412 Harmful to aquatic life with long lasting effects.
Skin Sens. 1:	H317 May cause an allergic skin reaction.

### 2.3. Label elements

Please observe all warning labels and notifications on the battery package and enclosure. Exemplary data plate containing the set of basic battery pack parameters, as required by law.



Crossed out wheellie bin symbol explains that after use batteries should be taken to separate collection for recycling. Do not dispose of them as unsorted municipal waste. Refer to chapter "Used batteries" for details on the recycling procedure.

"Li-ion" is the description of electrochemical system of battery pack





Black universal recycling symbol U+267B



Warning against electric shock.

Exercise caution when connecting the battery pack to the system. Mind the stickers at each connector on the battery pack front panel.

Please follow all safety symbols on battery enclosure/package.

## 2.4. Other hazards

Physico-chemical hazards

At temperatures over 70 °C risk of bursting and withdrawal of electrolyte liquid exists. When a cell is exposed to an external short-circuit, it will cause heat generation and ignition. Reactions of the electrolyte and the electrodes with water and humidity are possible.

Human health dangers

The contained dangerous materials are not freely available for foreseeable use.

Other hazards

none

## 3. Composition/information on ingredients

The chemical components of the battery are enclosed in the container to have no hazard as a battery. The battery is a lithium ion battery and its improper use may cause deformation, leakage of electrolytes (liquid in the battery), overheating, bursting, fire, or generation of stimulus/corrosive gas. Be sure to observe the warning and instructions as these events result in injury and equipment failure. Due to the chemical composition of the lithium-ion battery belongs to the group of dangerous goods and requires special treatment.

In case of electrolyte leakage from the battery:

Acute toxicity: Oral (rat) LD50 >2g/kg (estimated per cell)

Irritation: Irritating to eyes and skin

Mutagenicity: Not specified

Chronic toxicity: Not specified

### Composiition of Li-ion cell

Dangerous component	A range of concentration or concentration.	CAS NO.
NCM	32%-38%	/
carbon	0.5%-2.0%	7440-44-0
copper	5%-10%	7440-50-8
graphite	18%-24%	7782-42-5
Polyvinylidene fluoride	0.1%-1%	24937-79-9
aluminum	10%-15%	7429-90-5
Ethylene carbonate	15%-20%	96-49-1
lithium	1%-4%	7439-93-2

The concentrations of the ingredients are valid for cells. They are not for the complete system. The structural design of the cells prevents the release of the hazardous media contained therein when the unit is used for its intended purpose.

## 4. First – aid measures

### 4.1. Description of first aid measures

#### General first aid actions

Apply existing general rules concerning first aid. Especially, observe the following guidelines:

- Move the injured to a safe place (at least 50 meters from the dangerous area) in the fresh air.
- Perform cardiorespiratory resuscitation (CPR) if the victim is not breathing.
- Call emergency medical service.

### Electrolyte exposure

An electrolyte is a chemical substance contained in battery cells. Due to mechanical damage, the substance may leak outside the battery enclosure. Electrolyte leaking from the battery emanates a typical sweet odour.

#### Actions:

- Consult a doctor immediately.
- Remove the victim into fresh air and keep him calm.
- Remove and isolate contaminated clothing and shoes (of the injured and your own).
- In case of contact skin with electrolyte, immediately flush skin with lukewarm water with dishwashing soap or soap until medical help arrives; flush eyes with running water until medical help arrives. Consult a doctor if skin irritation persists.
- In case of contact eye with electrolyte rinse cautiously with water for several minutes. Remove contact lenses, if present and easy to do. Continue rinsing. Shield unaffected eye. If eye irritation persists get medical advice/attention.
- In case of electrolyte swallowing do NOT induce vomiting. Swallowing may cause gastrointestinal tract burns, nausea, and vomiting.
- After inhalation of vapour or swallowing of electrolyte seek medical help immediately.
- Inform medical personnel of substances and materials involved. Ensure they took appropriate precautions to protect themselves.

#### Electric shock

- Person after electric shock should be checked for internal injuries even if he or she has no obvious and visible symptoms.

## 4.2. Most important symptoms and effects, both acute and delayed

No information available.

## 4.3. Indication of any immediate medical attention and special treatment needed

### Electrolyte exposure

- Wear protective gloves.
- Remove and isolate any clothing which had contact with electrolyte.
- Make sure you only use medicinal products which do not irritate patient's wounds and do not trigger chemical reaction with electrolyte within wounds.

### Electric shock

- Do not assume the patient to be well after surviving an electric shock. Even when (s)he is conscious hospitalization and examination of internal organs are needed.

## 5. Fire – fighting measures

### 5.1. Extinguishing media

According to local fire protection regulations. CO<sub>2</sub>, metal fire-ex powder or dry powder extinguisher are recommended by the battery manufacturer. When the battery is on fire then water is allowed only to a cooling casing of the battery. When the battery is open and cells are visible, water is forbidden extinguishing media to be used directly on the cells.

### 5.2. Special hazards arising from the substance or mixture

Hazardous combustion products: carbon monoxide, carbon dioxide, lithium oxide fumes.

Conditions under which flammability could occur are mechanical damage of battery enclosure, vehicle collision, overcharge, significant rise of temperature in battery pack cells, etc.

### 5.3. Advice for firefighters

Prevent the inhalation of toxic gas and carry out extinguishment from the windward.

Proceed according to local fire regulations.

Special hazards arising from the substance or mixture:

- Hydrogen fluoride (HF)
- Risk of formation of toxic pyrolysis products
- Bursting batteries can be forcibly projected from a fire

#### Fire fighting procedures for user:

##### Fire as the result of collision/ road accident/ severe impact

- Each vehicle should be equipped with extinguishing agents and safety equipment according to effective local fire protection regulations. It is recommended that each vehicle running on lithium-ion batteries has CO<sub>2</sub>, metal fire-ex powder, or dry-powder fire extinguishers on board.
- In case of severe impact/shock (even when there is no visible damage) inform fire brigade immediately; give information about the vehicle- state clearly that the vehicle is electric, inform about the type of potential fire (D) and burning substance - chemistry inside battery cells (section “Composition/information on ingredients” of this document); the short circuit is possible due to broken battery insulation even after vehicle power shut off.
- Do not extinguish battery fire. The risk of toxic vapour inhalation and severe burns is too high.
- Remain at the disposal of the fire brigade when they arrive.

##### Fire in a storage area

- Storage area should be prepared and equipped according to local fire prevention inspector prescription in compliance with effective local laws. It is recommended that the area has: CO<sub>2</sub>, metal fire-ex powder or dry powder fire extinguishers (2 pieces, capacity – 6 kg), and personal protective equipment: respirators, dielectric insulating gloves. Water extinguishers are forbidden.

- Battery fire danger is not recognized only by sparks and flames. Other potential fire symptoms are leaking fluids, increased temperature, and disturbing sounds such as bubbling or gurgling inside the battery.
- Remain upwind of the fire.
- Call for medical help and provide first aid to the injured (see section “First – aid measures”).
- Call the fire brigade and inform them about the accident; give them information about the vehicle- state clearly that the vehicle contain lithium-ion batteries, inform about the type of fire (D) and burning substance - chemistry inside battery cells (section “Composition/information on ingredients” of this document).
- Remain at the disposal of the fire brigade when they arrive.
- Do not extinguish battery fire yourself unless you have specialised equipment and attended the training. The risk of toxic vapour inhalation and severe burns is too high.
- To minimise damage to company goods and property before the fire brigade arrives use prescribed by local the fire prevention inspector personal protective equipment when extinguishing the fire. Prevent the inhalation of toxic gas and carry out extinguishment from the windward.
- The fire should be extinguished by the fire brigade with suitable extinguishing media.

#### Fire during charging

- Battery fire danger is not only recognized by sparks and flames but potential fire symptoms are leaking fluids, increased temperature, bubbling or gurgling sounds inside the battery.
- If it is safe to disconnect power from the battery (disconnect from the grid/ disable current flow in the battery) – use an emergency power disconnect switch in the building/ area.
- Remain upwind of the fire.
- Call for medical help and provide first aid to the injured (see section “First - aid measures”).
- Call the fire brigade and inform about accident; give them information about the vehicle- state clearly that the vehicle is electric, inform them about the type of fire (D) and burning substance - chemistry inside battery cells (section “Composition/information on ingredients” of this document).
- Remain at the disposal of the fire brigade when they arrive.
- Do not extinguish battery fire yourself unless you have specialized equipment and attended the training. The risk of toxic vapour inhalation and severe burns is too high.
- To minimise damage to company goods and property before the fire brigade arrives use prescribed by local fire prevention inspector personal protective equipment when extinguishing a fire. Prevent the inhalation of toxic gas and carry out extinguishment from the windward.
- The fire should be extinguished by the fire brigade with suitable extinguishing media.

#### Additional advice for firefighters

- Use self-contained breathing apparatus

- Wear a fully protective suit
- Cool containers at risk with water spray jet
- Fire residues and contaminated firefighting water must be disposed of in accordance with the local regulations

## 6. Accidental release measures

### 6.1. Personal precautions, protective equipment and emergency procedures

An electrolyte is a chemical substance contained in the battery cells. Due to mechanical damage, the substance may leak outside the battery enclosure. Electrolyte leaking from battery emanates a typical sweet odour. When it is detected the following steps apply:

- Lock - off contaminated area.
- Use personal protective equipment: safety glasses, gloves, solvent-resistant protective clothing.
- Keep people away and stay on the upwind side.
- Evacuate people to a safe distance of at least 50 meters.
- Use breathing apparatus if exposed to vapours/dust/aerosol.
- Call for medical help and provide first aid (see chapter "First - aid measures").
- Call the fire brigade immediately after you detect the leakage.
- Take off clothes that have absorbed electrolyte and isolate contaminated clothing and shoes in a glass container.
- Do not touch or walk through spilled substance.
- Eliminate all ignition sources (no smoking, flares, sparks or flames in immediate area) if possible.
- If you are in possession of proper personal protective equipment as prescribed by local fire protection regulations you may absorb the substance with a sorbing agent such as earth, sand or other non-combustible, non-conductive material and dispose of it in a glass container or plastic bag.
- Inform fire brigade about the substance involved so they can efficiently fight fire or get rid of chemical substance residue.
- Leaking batteries and contaminated absorbent material should be placed in insulating containers or left outside the building for vapour to escape.
- Inform manufacturer.

### 6.2. Environmental precautions

Do not discharge leakages into the drains/surface waters/groundwater.

The contents of chemical modules are slowly bio-degradable as stated by the cell manufacturer.

### 6.3. Methods and material for containment and cleaning up

- Take up mechanically.
- If you are in possession of proper personal protective equipment as prescribed by local fire protection regulations you may absorb the substance with a sorbing agent such as earth, sand or other non-combustible, non-conductive material and dispose of it in a glass container or plastic bag.
- Dispose of absorbed material in accordance with the regulations.
- Leaking batteries and contaminated absorbent material should be placed in insulating containers or left outside the building for vapour to escape.

### 6.4. Reference to other sections

## 7. Handling and storage

### 7.1. Precautions for safe handling

Precaution measures concerning battery placement as well as storage area conditions are described in the subsection below.

Due to the weight of batteries, for moving them inside storage it is recommended to use a forklift.

To facilitate the lifting batteries should be placed in UN certified boxes.

### 7.2. Conditions for safe storage, including any incompatibilities

#### Precautions for safe handling

Be sure to comply with all the items described in the delivery specification and manual including below:

- Person who handles the battery is sure to take off metal articles such as a watch, put on protective gloves, and safety shoes.
- When connecting the cable to the battery be sure to use an insulated tool.
- Do not disassemble or modify the battery.
- Do not short circuit (+) and (-) terminals with conductive material.
- Do not throw the battery into the fire, or expose it to heating.
- Do not use or leave the cell near a fire or in a very hot place.
- Do not drive nails in the battery, or strike it with a hammer, or step on it in fear of deformation or damage to protection mechanisms.
- Do not expose the battery to strong shocks due to fall, or throw it.
- Do not use the cell exposed to shocks due to fall.
- Do not allow the battery to become wet with water or seawater or rain.
- Do not install the battery backwards so that the polarity is reversed.
- Do not charge nor discharge under unspecified conditions.
- Do not connect several batteries in series or parallel.

- When handling the battery, be sure to comply with the specified rules to connect the battery.
- Do not use or test damaged battery.
- When disorder in the cell or misuse causes abrupt battery temperature rise with gas emission or smoke or fire, cool it with sand or powdery fire extinguisher or CO2 extinguisher.
- During long-term storage be sure to keep the battery voltage properly in order not to make it below specified voltage. Before the start of operation in the vehicle, terminal voltage has to be checked by CAN interface if it is in operating range.
- Be sure to store the battery in the place where the battery could not be exposed to a raindrop, avoiding direct sunlight, hot-temperature, high humidity, place of the use of fire.

**Handling practices and equipment:**

- Storage room should be prepared and equipped according to local fire prevention inspector prescription in compliance with effective local laws. It is recommended that it is well ventilated and dry (explosion venting system), its walls are made of non-flammable materials, and its doors are at least 30-minute-rated fire doors.
- Other flammable materials should not be stored in the same area to prevent spread of potential fire.
- Optimal temperature range for long-term (longer than 14 days) storage is +15°C to + 25°C. Storage outside this range is not recommended.
- Allowed temperature range for short-term ( $\leq 14$  days) storage is -30°C to 40°C.
- Humidity in storage place should not exceed 80%.
- Storage area should be prepared and equipped according to local fire prevention inspector prescription in compliance with effective local laws. It is recommended that the area has: CO2, metal fire-ex powder or dry powder fire extinguishers (2 pieces, capacity – 6 kg) and personal protective equipment: respirators, dielectric insulating gloves. Water extinguishers are forbidden.

**Stored batteries – properties, storing position, protection**

- It is recommended to store each battery pack in a UN38.3 certified box (the type of box for safe storage should be determined by local fire protection inspector or other authorised person) to isolate it from potential adverse thermal conditions and/or on a separate wooden pallet to enable quick transfer of battery to an isolated area/outdoors in case of internal heat/fire/short circuit symptoms.
- Battery connectors not protected against environmental factors (e.g. rain, snow, humidity) especially when signal and power harnesses have been disconnected, need to be covered with compatible hoods, counter connectors or connector caps. Remember to protect the detached power harness connectors with compatible hoods, counter connectors, connector caps.
- Lithium-ion battery should be stored being charged to 30%-50% of SOC. After 6-month storage battery SOC needs to be checked and recharged if needed.
- Li-ion battery self-discharge is around 2% of charge loss a month.
- Battery should be stored in the target operating position.
- Do not store adjacent to combustible materials.
- Protect from heat and overheating.
- Protect from sun.
- Store in a dry place.
- Ensure battery terminals are protected during storage.
- Protect from atmospheric moisture, water and contamination.



#### Storage of batteries to be diagnosed

Batteries that await manufacturer diagnosis, especially after a road accident or mechanically damaged, should be stored in a separate area/room in UN certified transport boxes.

#### Storage of batteries to be repaired

Batteries qualified for repair can be safely stored in UN certified boxes in the same room with new batteries.

#### Storage of used batteries

Used battery - is a battery that is no longer effective in terms of power-supplying its target application. In order to classify the battery as "used" , a manufacturer's diagnosis is not required.

Used batteries can be safely stored in the same room with new batteries.

#### Storage of damaged batteries

Immediately isolate the batteries in a safe place if, during operation, they emit an unusual smell, develop heat, change shape/geometry, emit disturbing sounds or behave abnormally which may indicate a problem. Additionally damaged batteries must be stored in a well-ventilated area and protected from third-party access. They must be separated from other batteries. If there is a fire hazard involved - inform the fire brigade and the manufacturer immediately. The storage area must be equipped with fire extinguisher applicable for this battery.

For safety reasons damaged batteries/cells should not be stored at user's facilities. They should be disposed of in compliance with applicable regulations. Batteries qualified as permanently damaged shall be transported to the nearest waste recycling point.

### 7.3. Specific end use(s)

See product use, section 1.2

## 8. Exposure controls and personal protection

#### Exposure controls

##### Applicable control measures, including engineering controls:

- It is recommended to equip storage and mounting area with proper ventilation system in compliance with existing local fire protection regulations.
- Walls of storage area should be non-flammable, doors should be at least 30-minute rated fire doors.
- If not agreed otherwise any mounting, service and repair works should be performed by authorised and trained personnel only.
- Operation manual describing safety procedures is available to handling personnel/ bus driver at all times.
- Battery pack is contained in insulating housing.
- Battery packs are transported and stored in insulating UN38.3 certified boxes.

##### Personal protection measure for each exposure route:

Personal protective equipment should be compliant with existing local fire protection regulations. The below sections contain battery manufacturer recommendations.

**PPE for electrolyte exposure and toxic fumes exposure:**

- Lock off the contaminated area
- Use personal protective equipment: safety glasses, gloves, solvent-resistant protective clothing
- Keep people away and stay on the upwind side
- Use breathing apparatus if exposed to vapours/dust/aerosol

**PPE for electric shock**

dielectric insulating gloves, insulating shoes

## 9. Physical and chemical properties

### 9.1. Lithium-ion Cell

**Appearance**

Lithium Ion Rechargeable Cell (Prismatic)

**Nominal Voltage**

Single cell - 3.7 V

**Appearance**

Lithium Ion Rechargeable Cell is stored in the plastic resin case or tube.

**Nominal Voltage**

The voltage value depends on the number of built-in batteries used in battery modules and battery pack.

**Electrolyte****Appearance**

Transparent liquid.

**Odour**

Smells like medical ether, a little bit sweet.

**Odour threshold**

No available information.

**pH**

No available information.

**Freezing/melting point**

No available information.

**Boiling point**

No available information.

**Flash point**

No available information.

**Evaporation rate**

No available information.

**Flammability (solid, gas)**

H226 Flammable liquid and vapour.

**Upper/lower flammability or explosive limits**

No available information.

**Vapour pressure and reference temperature**

No available information.

**Vapour density**

No available information.

**Relative density**

No available information.

**Solubility in water**

No available information.

**Partition coefficient: n-octanol/water**

No available information.

**Auto-ignition temperature**

No available information.

**Decomposition temperature**

No available information.

**Viscosity**

No available information.

## 9.2. Battery pack

### Appearance

Rectangular painted stainless steel (1.4301) case containing electronics and lithium-ion cells.

### Nominal Voltage

All variants – 222 V

### Minimum Voltage

All variants – 180 V

### Maximum Voltage

All variants – 261 V

### Nominal energy

All variants – 39,29 kWh

### Nominal capacity

All variants – 177 Ah

### Storage temperature

All variants – -30 to +55 °C

## 10. Stability and reactivity

### 10.1. Reactivity

No available information.

### 10.2. Chemical stability

Product is stable under conditions described in section “Handling and storage”.

### 10.3. Possibility of hazardous reactions

H319 Causes serious eye irritation

H317 May cause an allergic skin reaction

H411 Toxic to aquatic life with long lasting effects

H312 Harmful in contact with skin

H372 Causes damage to organs through prolonged or repeated exposure

H318 Causes serious eye damage

H314 Causes severe skin burns and eye damage

H301 Toxic if swallowed

H335 May cause respiratory irritation

H315 Causes skin irritation

#### 10.4. Conditions to avoid

- Heat above 70°C
- Deformation-, mutilation-, crush- risk encouraging conditions
- Overcharge
- Short circuit
- Exposure to humid conditions over a long period (greater than 6 months)

#### 10.5. Incompatible materials

- Oxidizing agents
- Alkalis
- Water

#### 10.6. Hazardous decomposition products

- toxic fumes as the result of burning of chemical content of battery cells
- may form peroxides

Item	After thermal event [%]
CH4	4,00
C2H4	6,60
C2H2	0,04
C2H6	1,51
C3H8	0,41
C3H6	0,15
C3H4	0,01
i-C4H10	3,42
n-C4H10	2,77
I-C4H8	0,09
N-C4H8	0,18
C4H6	0,10
trans-C4H8	0,56
cis-C4H10	0,01
1,3-C4H6	0,01
H2	16,33
CO2	34,87
O2	1,17
N2	8,66

CO	19,60
----	-------

## 11. Toxicological information

Not applicable unless the battery is mechanically broken.

### 11.1. Information on toxicological effects

Vapor generated from burning batteries, may make eyes, skin and throat irritate.

Not required under normal conditions.

## 12. Ecological information

### 12.1. Toxicity

Composiition of Li-ion cell:

**Carbon LD50** :8000 mg/kg (Mouse transoral)

**Lithium LD50** :1000 mg/kg (Intraperitoneal in mice)

**Ethylene carbonate LD50** : 10 g/kg (Rat's mouth)

**Skin irritation or corrosion** : nothing

**Eye irritation or coeession** : nothing

**Respiratory or skin allergy** : nothing

**Mutagenicity of germ cells** : nothing

**Carcinogenicity** :

Carbon-According to ACGIH, IARC, NTP Not listed as a carcinogen

Copper- According to ACGIH, IARC, NTP Not listed as a carcinogen

**Graphite-IARC:** International research institutes have not confirmed that products containing 0.1% or more of the substance may be identified as human carcinogens.

**Polyvinylidene fluoride - IARC:** International research institutes have not confirmed that products containing 0.1% or more of the substance may be identified as human carcinogens.

Aluminum- According to ACGIH, IARC, NTP Not listed as a carcinogen

**Ethylene carbonate- IARC:** International research institutes have not confirmed that products containing 0.1% or more of the substance may be identified as human carcinogens.

**Lithium- IARC:** International research institutes have not confirmed that products containing 0.1% or more of the substance may be identified as human carcinogens.

**Reproductive toxicity** : No data

**Specific target organ system toxicity (one contact)** : No data

**Specific target organ system toxicity (Repeated contact)** : No data

**Inhalation hazards** : No data

**Pharmacokinetics, metabolism and distribution information** : No data

## 12.2. Persistence and degradability

Not applicable.

## 12.3. Bioaccumulative potential

Not applicable.

## 12.4. Mobility in soil

Not applicable.

## 12.5. Results of PBT and vPvB assessment

Not applicable.

## 12.6. Other adverse effects

Ecological data of complete product are not available.

Do not discharge product unmonitored into the environment or into the drainage.

## 13. Disposal considerations

### 13.1. Waste treatment methods

Permanently damaged battery should not be reprocessed along with residential garbage. The disposal of lithium-ion batteries shall be carried out in compliance with the relevant laws and regulations of the country where the batteries are in service.

Note to vehicle manufacturer: report any permanently damaged/used batteries to ICPT S.A. at [logistyka@icpt.pl](mailto:logistyka@icpt.pl) and +48 22 758 68 65. Please refer to battery serial number, type, and year of production or purchase order number to facilitate the process. Mechanically damaged batteries should be kept outdoors at safe distance from other devices and vehicles.

Information from module manufacturer: it is recommended to fully discharge the battery, use up the metal lithium from the inside of battery.

## 14. Transport information

Land, air, and sea transport of lithium batteries is regulated by local and international laws.

### 14.1. UN numer

As lithium-ion battery contains lithium, it is defined as dangerous good number UN3480, class 9 (Miscellaneous dangerous substances and articles, including environmentally hazardous substances) according to classification adopted in document „Recommendations on the transport of dangerous goods Vol. I”. Criteria of UN „Manual of tests and criteria”, section 38.3. as well as other effective laws are applied to transport of lithium-ion batteries. It refers to transport across Europe itself and all around the world.

## 14.2. UN proper shipping name

The battery is made from YXE8A3-174Ah-1P4S-355 modules which are UN38.3 certified.

## 14.3. Transport hazard class(es)

Battery packs belong to ADR Class 9A - miscellaneous dangerous goods.

## 14.4. Packing group

Battery should be packed into appropriate and dedicated packaging which meets regulations specified in Packing Instruction P903, in document „Recommendations on the transport of dangerous goods Vol. II”. Packaging needs to meet the quality requirements of packing group II.

## 14.5. Environmental hazards

Please refer to sections “Composition/information on ingredients” and “Ecological information”.

## 14.6. Special precautions for user

### Before unpacking

Before unpacking make sure that:

- the packaging is not damaged in any way,
- the package content reflects the waybill list and your order specification.

The connectors' covers should not be removed from battery from the moment of unpacking of the battery till its connection to charging equipment or its placement in target device/vehicle.

### General transport and lading information

For land and sea transport of prototype li-ion batteries (up to 200 pieces of a given type) it is required to attach to the parcel the battery data sheet, MSDS, declaration of qualified institution dealing with packing and clearance of dangerous goods e.g. DGM.

ICPT batteries have necessary approval of the Civil Aviation Authority of Poland. Air transport is possible via cargo aircraft. It is required to attach to parcel the battery data sheet, MSDS, and declaration of qualified institution dealing with packing and clearance of dangerous goods. The permission is not effective in case of transport to the USA. For the time of air transport each battery should be charged up to 30% of SOC in compliance with IATA Packing Instruction PI 965, chapter 11.

For sea transport of dangerous goods the guidelines of International Maritime Dangerous Goods Code (IMDGC) apply.

If possible protect battery connectors against water and short circuit with connector covers or counter connectors. Packaging should protect battery from mechanical damage and short circuit in transport.

Out of order batteries, which have been qualified for repair by authorised ICPT S.A. service team, have to be transported in UN certified boxes, packing group II.



## 15. Regulatory information

### 15.1. Safety, health and environmental regulations/legislation specific for the substance or mixture

Land, air, and sea transport of lithium batteries is regulated by local and international laws such as:

- “Recommendations on the transport of dangerous goods”
- UN “Manual of tests and criteria”
- IATA “Dangerous Goods Regulation”
- “International Maritime Dangerous Goods Code” (IMDGC).

### 15.2. Chemical safety assessment

No information available.

## 16. Other information

### General disclaimer

This information contained in this safety instruction represents the best information currently available to ICPT based on its knowledge and experience as the manufacturer of the battery systems. Please follow strictly this instruction to ensure a safe usage, storage and handling of the product. It is advised that users of ICPT products take any suitable precautions to protect their life and health. ICPT does not accept any liability for any damages resulting from faulty use, unintended use or not following this safety instruction when using the product. In case you notice any irregularities of the product, please contact ICPT immediately on our emergency phone number. Should you have any questions related to the usage of the product please send us an e-mail at [support@icpt.pl](mailto:support@icpt.pl).

ICPT reserves the right to modify or update this safety instruction in order to adjust it to the laws, regulations and safety requirements.



## SAFETY DATA SHEET

According to Regulation (EC) No. 1907/2006 (REACH) Article 31, Annex II as amended.

### SECTION 1: Identification of the substance/mixture and of the company/undertaking

#### 1.1 Product identifier

**Product name:** TITAN ATF 4000

#### 1.2 Relevant identified uses of the substance or mixture and uses advised against

**Identified uses:** Lubricant

**Uses advised against:** No uses advised against identified.

#### 1.3 Details of the supplier of the safety data sheet

**Manufacturer / Supplier** FUCHS LUBRICANTS GERMANY GmbH  
Friesenheimer Str. 19  
68169 Mannheim

Telephone: +49 621 3701-0 (ZENTRALE)  
Fax: +49 621 3701-570

#### Contact for request of safety data sheets

E-mail: Automotive lubricants automotive-FLG@fuchs.com  
Industrial lubricants industrie-FLG@fuchs.com  
Telephone: +49 621 3701-0 (ZENTRALE)

#### Informing department for safety data sheets

E-mail: produktsicherheit-FLG@fuchs.com

**1.4 Emergency telephone number:** +49 621 3701-0 (Mo - Fr 08:00 - 16:00 Uhr)

### SECTION 2: Hazards identification

#### 2.1 Classification of the substance or mixture

The product has been classified and labelled as hazardous according to regulation (EU) 1272/2008 (CLP).

**Classification according to Regulation (EC) No 1272/2008 as amended.**

##### Environmental Hazards

Chronic hazards to the aquatic environment Category 3 H412: Harmful to aquatic life with long lasting effects.

##### Hazard summary

**Physical Hazards:** No data available.

#### 2.2 Label Elements

**Product name:** TITAN ATF 4000

**Hazard Statement(s):** H412: Harmful to aquatic life with long lasting effects.

**Precautionary Statements**

**Prevention:** P273: Avoid release to the environment.

**Disposal:** P501: Dispose of contents/container to an appropriate treatment and disposal facility in accordance with applicable laws and regulations, and product characteristics at time of disposal.

**2.3 Other hazards:** By handling of mineral oil products and chemical products no particular hazard is known when normal precautions (item 7) and personal protective equipment (item 8) are kept. The product may not be released into the environment without control.

**SECTION 3: Composition/information on ingredients**

**3.2 Mixtures**

**General information:** Mixture containing severely refined base oils and additives.

Chemical name	Identifier	Concentration *	REACH Registration No.	Notes
Methacrylate copolymer	Confidential	1,00% - <5,00%	Confidential	
Base oil, low viscous	EINECS: 265-158-7	1,00% - <10,00%	01-2119487077-29	
Alkyl amine	EC: 620-540-6	0,25% - <1,00%	01-2119510877-33	
prim. alkanolamine ether	EC: 939-485-7	0,001% - <0,10%	01-2119974116-35	

\* All concentrations are percent by weight unless ingredient is a gas. Gas concentrations are in percent by volume.

PBT: persistent, bioaccumulative and toxic substance.

vPvB: very persistent and very bioaccumulative substance.

**Classification**

Chemical name	Identifier	Classification
Methacrylate copolymer	Confidential	CLP: Eye Irrit. 2;H319
Base oil, low viscous	EINECS: 265-158-7	CLP: Asp. Tox. 1;H304
Alkyl amine	EC: 620-540-6	CLP: Skin Corr. 1C;H314, Eye Dam. 1;H318, Aquatic Acute 1;H400, Aquatic Chronic 1;H410, Acute Tox. 4;H302; M-Factor (aquatic acute): 10; M-Factor (aquatic chronic): 1
prim. alkanolamine ether	EC: 939-485-7	CLP: Acute Tox. 4;H302, Skin Corr. 1B;H314, Eye Dam. 1;H318, Aquatic Acute 1;H400, Aquatic Chronic 1;H410; M-Factor (aquatic acute): 100; M-Factor (aquatic chronic): 1

CLP: Regulation No. 1272/2008.

**specific concentration limit**

Chemical name	Identifier	specific concentration limit	Hazard class	Hazard Category	Hazard statements
Methacrylate copolymer	Confidential	>= 75 %	Serious eye irritation	2	H319

**Product name:** TITAN ATF 4000

For the wording of the listed hazard statements refer to section 16.

Please note that the mineral oils and petroleum distillates used in our products are severely refined and have a DMSO extract < 3% as measured by method IP 346 and are not classified as carcinogenic according to Note L of Annex VI of Regulation EC 1272/2008."

#### SECTION 4: First aid measures

**General:** Instantly remove any clothing soiled by the product.

##### 4.1 Description of first aid measures

**Inhalation:** Supply fresh air; consult doctor in case of symptoms.

**Eye contact:** Promptly wash eyes with plenty of water while lifting the eye lids.

**Skin Contact:** Wash with soap and water.

**Ingestion:** Rinse mouth thoroughly.

**4.2 Most important symptoms and effects, both acute and delayed:** May cause skin and eye irritation.

**4.3 Indication of any immediate medical attention and special treatment needed** Get medical attention if symptoms occur.

#### SECTION 5: Firefighting measures

##### 5.1 Extinguishing media

**Suitable extinguishing media:** CO<sub>2</sub>, fire extinguishing powder or fog like water spraying. Extinguish larger fires with alcohol resistant foam or spray water with suitable surfactant added

**Unsuitable extinguishing media:** Water with a full water jet.

**5.2 Special hazards arising from the substance or mixture:** During fire, gases hazardous to health may be formed.

##### 5.3 Advice for firefighters

**Special fire-fighting procedures:** Move container from fire area if it can be done without risk. Dispose of fire debris and contaminated fire fighting water in accordance with official regulations. Collect contaminated fire fighting water separately. It must not enter drains.

**Special protective equipment for fire-fighters:** Self-contained breathing apparatus and full protective clothing must be worn in case of fire.

**Product name:** TITAN ATF 4000

**SECTION 6: Accidental release measures**

- 6.1 Personal precautions, protective equipment and emergency procedures:** In case of spills, beware of slippery floors and surfaces.
- 6.2 Environmental Precautions:** Avoid release to the environment. Prevent further leakage or spillage if safe to do so. Prevent from spreading (e.g. by binding or oil barriers). Environmental manager must be informed of all major spillages. Do not allow to enter drainage system, surface or ground water.
- 6.3 Methods and material for containment and cleaning up:** Absorb with liquid-binding material (sand, diatomite, acidbinders, universal binders, sawdust). Dispose of the material collected according to regulations. Stop the flow of material, if this is without risk.
- 6.4 Reference to other sections:** See Section 8 of the SDS for Personal Protective Equipment. See Section 7 for information on safe handling See Section 13 for information on disposal.

**SECTION 7: Handling and storage:**

- 7.1 Precautions for safe handling:** Prevent formation of aerosols. Do not eat, drink or smoke when working with the product. Take usual precautions when handling mineral oil products or chemical products. Observe good industrial hygiene practices. Provide adequate ventilation.
- 7.2 Conditions for safe storage, including any incompatibilities:** Local regulations concerning handling and storage of waterpolluting products have to be followed. Do not heat up to temperatures close to the flash point.
- 7.3 Specific end use(s):** Not applicable

**Storage Class:** 10, Combustible liquids

**SECTION 8: Exposure controls/personal protection**

**8.1 Control Parameters**

**Occupational Exposure Limits**

Chemical name	Type	Exposure Limit Values	Source
Base oil, low viscous - Respirable fraction.	MAK	5 mg/m3	Germany. DFG MAK List (advisory OELs). Commission for the Investigation of Health Hazards of Chemical Compounds in the Work Area (DFG), as amended (2017)

**8.2 Exposure controls**

**Appropriate engineering controls:** Provide adequate ventilation. Ventilation rates should be matched to conditions. If applicable, use process enclosures, local exhaust ventilation, or other engineering controls to maintain airborne levels below recommended exposure limits. If exposure limits have not been established, maintain airborne levels to an acceptable level.

**Individual protection measures, such as personal protective equipment**

**Product name:** TITAN ATF 4000

<b>General information:</b>	Wash hands before breaks and after work. Use personal protective equipment as required. Personal protection equipment should be chosen according to the CEN standards and in discussion with the supplier of the personal protective equipment. The usual precautionary measures should be adhered to in handling the chemicals or the mineral oil products.
<b>Eye/face protection:</b>	Safety glasses (EN 166) recommended during refilling. Avoid contact with skin and eyes. Goggles/face shield are recommended. If risk of splashing, wear safety goggles or face shield.
<b>Skin protection</b>	
<b>Hand Protection:</b>	Material: Nitrile butyl rubber (NBR). Min. Breakthrough time: >= 480 min Recommended thickness of the material: >= 0,38 mm
	Avoid long-term and repeated skin contact. Suitable gloves can be recommended by the glove supplier. Use skin protection cream for preventive skin protection. Protective gloves, where permitted in acc. to safety directions. The exact break through time has to be found out by the manufacturer of the protective gloves and has to be observed.
<b>Other:</b>	Do not carry cleaning cloths impregnated with the product in trouser pockets. Wear suitable protective clothing.
<b>Respiratory Protection:</b>	Ensure good ventilation/exhaustion at the workplace. Avoid breathing vapour/ aerosol.
<b>Thermal hazards:</b>	Not known.
<b>Hygiene measures:</b>	Always observe good personal hygiene measures, such as washing after handling the material and before eating, drinking, and/or smoking. Routinely wash work clothing to remove contaminants. Discard contaminated footwear that cannot be cleaned.
<b>Environmental Controls:</b>	No data available.

**SECTION 9: Physical and chemical properties**

**9.1 Information on basic physical and chemical properties**

**Appearance**

<b>Physical state:</b>	liquid
<b>Form:</b>	liquid
<b>Color:</b>	Red
<b>Odor:</b>	Characteristic
<b>pH:</b>	substance/mixture is non-soluble (in water)
<b>Freezing point:</b>	not determined
<b>Boiling Point:</b>	Not applicable
<b>Flash Point:</b>	190 °C
<b>Evaporation Rate:</b>	Not applicable for mixtures
<b>Flammability (solid, gas):</b>	not determined
<b>Flammability Limit - Upper (%)–:</b>	Not applicable for mixtures

**Product name:** TITAN ATF 4000

<b>Flammability Limit - Lower (%)–:</b>	Not applicable for mixtures
<b>Vapor pressure:</b>	Not applicable for mixtures
<b>Relative vapor density:</b>	Not applicable for mixtures
<b>Density:</b>	0,86 g/ml (15,00 °C)
<b>Solubility(ies)</b>	
<b>Solubility in Water:</b>	Insoluble in water
<b>Solubility (other):</b>	No data available.
<b>Partition coefficient (n-octanol/water):</b>	Not applicable for mixtures
<b>Autoignition Temperature:</b>	not determined
<b>Decomposition Temperature:</b>	not determined
<b>Kinematic viscosity:</b>	35,9 mm <sup>2</sup> /s (40 °C)
<b>Explosive properties:</b>	Value not relevant for classification
<b>Oxidizing properties:</b>	Value not relevant for classification
<b>Particle characteristics:</b>	Not applicable
<b>9.2 Other information</b>	No data available.

## SECTION 10: Stability and reactivity

<b>10.1 Reactivity:</b>	Stable under normal use conditions.
<b>10.2 Chemical Stability:</b>	Stable under normal use conditions.
<b>10.3 Possibility of hazardous reactions:</b>	Stable under normal use conditions.
<b>10.4 Conditions to avoid:</b>	Stable under normal use conditions.
<b>10.5 Incompatible Materials:</b>	Strong oxidizing substances. Strong acids. Strong bases.
<b>10.6 Hazardous Decomposition Products:</b>	Thermal decomposition or combustion may liberate carbon oxides and other toxic gases or vapors.

## SECTION 11: Toxicological information

### 11.1 Information on toxicological effects

#### Acute toxicity

##### Oral

**Product:** Not classified for acute toxicity based on available data.

##### Specified substance(s)

Base oil, low viscous LD 50 (Rat): > 5.000 mg/kg

Alkyl amine LD 50 (Rat): 1.350 mg/kg (OECD 401)



**Product name:** TITAN ATF 4000

---

**Dermal**

**Product:** Not classified for acute toxicity based on available data.

**Specified substance(s)**

Base oil, low viscous LD 50 (Rabbit): > 5.000 mg/kg

**Inhalation**

**Product:** Not classified for acute toxicity based on available data.

**Specified substance(s)**

Base oil, low viscous LC 50 (Rat, 4 h): > 5 mg/l

**Skin Corrosion/Irritation:**

**Product:** Based on available data, the classification criteria are not met.

**Specified substance(s)**

Alkyl amine OECD 404 (Rabbit, 14 d):  
Causes severe skin burns.

**Serious Eye Damage/Eye Irritation:**

**Product:** Based on available data, the classification criteria are not met.

**Respiratory or Skin Sensitization:**

**Product:** Skin sensitizer: Based on available data, the classification criteria are not met.  
Respiratory sensitizer: Based on available data, the classification criteria are not met.

**Specified substance(s)**

Alkyl amine  
No sensitizing effect (guinea pig); OECD 406

**Germ Cell Mutagenicity**

**Product:** Based on available data, the classification criteria are not met.

**Carcinogenicity**

**Product:** Based on available data, the classification criteria are not met.

**Reproductive toxicity**

**Product:** Based on available data, the classification criteria are not met.

**Specific Target Organ Toxicity - Single Exposure**

**Product:** Based on available data, the classification criteria are not met.

**Specific Target Organ Toxicity - Repeated Exposure**

**Product:** Based on available data, the classification criteria are not met.

**Aspiration Hazard**

**Product:** Based on available data, the classification criteria are not met.

**Other adverse effects:**

No data available.

Product name: TITAN ATF 4000

## SECTION 12: Ecological information

### 12.1 Toxicity

#### Acute toxicity

**Product:** Based on available data, the classification criteria are not met.

#### Fish

**Specified substance(s)**  
Alkyl amine LC 50 (Fish, 96 h): 0,1 mg/l (OECD 203)

#### Aquatic Invertebrates

**Specified substance(s)**  
Alkyl amine EC 50 (Water Flea, 48 h): 0,043 mg/l (OECD 202)

**Chronic Toxicity Product:** Based on available data, the classification criteria are met.

#### Aquatic Invertebrates

**Specified substance(s)**  
Alkyl amine EC 10 (Water Flea, 21 d): 0,0107 mg/l (OECD 211)

#### Toxicity to Aquatic Plants

**Specified substance(s)**  
Alkyl amine EC 50 (Alga, 72 h): 0,0538 mg/l (OECD 201)  
NOEC (Alga, 72 h): 0,0156 mg/l

### 12.2 Persistence and Degradability

#### Biodegradation

**Product:** Not applicable for mixtures  
**Specified substance(s)**  
Alkyl amine 63 % (28 d, OECD 301D) Readily biodegradable

### 12.3 Bioaccumulative potential

**Product:** Not applicable for mixtures

### 12.4 Mobility in soil:

**Product:** Not applicable for mixtures

### 12.5 Results of PBT and vPvB assessment:

The product does not contain any substances fulfilling the PBT/vPvB criteria.

### 12.6 Other adverse effects:

Harmful to aquatic life with long lasting effects.

#### Water Hazard Class (WGK):

WGK 2: significantly water-endangering.

## SECTION 13: Disposal considerations

### 13.1 Waste treatment methods

**General information:** Dispose in accordance with all applicable regulations.

**Product name:** TITAN ATF 4000

**Disposal methods:** Discharge, treatment, or disposal may be subject to national, state, or local laws.

**European Waste Codes**

13 02 05\*: mineral-based non-chlorinated engine, gear and lubricating oils

**SECTION 14: Transport information**

**ADR/RID**

- 14.1 UN number or ID number: —
- 14.2 UN Proper Shipping Name: —
- 14.3 Transport Hazard Class(es)
  - Class: Non-dangerous goods
  - Label(s): —
  - Hazard No. (ADR): —
  - Tunnel restriction code: —
- 14.4 Packing Group: —
- 14.5 Environmental hazards: —
- 14.6 Special precautions for user: —

**IMDG**

- 14.1 UN number or ID number: —
- 14.2 UN Proper Shipping Name: —
- 14.3 Transport Hazard Class(es)
  - Class: Non-dangerous goods
  - Label(s): —
  - EmS No.: —
- 14.3 Packing Group: —
- 14.5 Environmental hazards: —
- 14.6 Special precautions for user: —

**IATA**

- 14.1 UN number or ID number: —
- 14.2 Proper Shipping Name: —
- 14.3 Transport Hazard Class(es):
  - Class: Non-dangerous goods
  - Label(s): —
- 14.4 Packing Group: —
- 14.5 Environmental hazards: —
- 14.6 Special precautions for user: —

**14.7 Transport in bulk according to Annex II of MARPOL and the IBC Code:** Not applicable.

**SECTION 15: Regulatory information**

**15.1 Safety, health and environmental regulations/legislation specific for the substance or mixture:**

**EU Regulations**

**EU. Regulation 1005/2009/EC on substances that deplete the ozone layer, Annex I, Controlled Substances:** none

**Product name:** TITAN ATF 4000

**EU. Regulation 2019/1021/EU on persistent organic pollutants (POPs) (recast), as amended:** none

**National Regulations**

**Water Hazard Class (WGK):** WGK 2: significantly water-endangering.

**15.2 Chemical safety assessment:** No Chemical Safety Assessment has been carried out.

**SECTION 16: Other information**

**Revision Information:** Vertical lines in the margin indicate an amendment.

**Wording of the H-statements in section 2 and 3**

H302	Harmful if swallowed.
H304	May be fatal if swallowed and enters airways.
H314	Causes severe skin burns and eye damage.
H318	Causes serious eye damage.
H319	Causes serious eye irritation.
H400	Very toxic to aquatic life.
H410	Very toxic to aquatic life with long lasting effects.
H412	Harmful to aquatic life with long lasting effects.

**Other information:** The classification complies with the current EU lists; however, it has been supplemented with expert literature information and information provided by/about our company. The following evaluation methods were used: - On the basis of test data - Calculation Method - Bridging Principle "Substantially similar mixtures" - Expert Judgement

**Revision Date:** 14.09.2022

**Disclaimer:** The data contained in this safety data sheet are based on our current knowledge and experience and are given to the best of our knowledge and belief. It characterizes the product only with regard to safety requirements for handling, transport and disposal. The data do not describe the product's properties (tech. product specification). Neither should any agreed property nor the suitability of the product for any specific technical application be deduced from the data contained in this safety data sheet. Modifications on this document are not allowed. The data are not transferable to other products. In the case of mixing the product with other products or in the case of processing, the data in this safety data sheet are not necessarily valid for the new-made material. It is the responsibility of the recipient of the product to observe federal, state and local law. Please contact us to obtain up-to-date safety data sheets. This document was issued electronically and has no signature.





**SAFETY DATA SHEET**

According to Regulation (EC) No. 1907/2006 (REACH) Article 31, Annex II as amended

**CH2F2 38,1110 %;C2HF5 17,9557 %;C2H2F4 43,9332 %**

Issue Date: 12.11.2014

Version: 3.0

SDS No.: 000010022600

Last revised date: 09.11.2023

1/18

**SECTION 1: Identification of the substance/mixture and of the company/undertaking****1.1 Product identifier****Product name:** CH2F2 38,1110 %;C2HF5 17,9557 %;C2H2F4 43,9332 %**Other Name:** Refrigerant R407C**1.2 Relevant identified uses of the substance or mixture and uses advised against****Identified uses:** Industrial and professional. Perform risk assessment prior to use.  
Refrigerant.**Uses advised against** Consumer use.**1.3 Details of the supplier of the safety data sheet****Supplier**BOC  
Priestley Road, Worsley  
M28 2UT Manchester**Telephone:** 0800 111 333**E-mail:** ReachSDS@boc.com**1.4 Emergency telephone number: 0800 111 333****SECTION 2: Hazards identification****2.1 Classification of the substance or mixture**

Classification (REGULATION (EC) No 1272/2008) as amended by GB-CLP Regulation, UK SI 2019/720, and UK SI 2020/1567)

**Physical Hazards**

Gases under pressure

Liquefied gas

H280: Contains gas under pressure; may explode if heated.

**2.2 Label Elements**

SDS\_GB

**SAFETY DATA SHEET**

According to Regulation (EC) No. 1907/2006 (REACH) Article 31, Annex II as amended

**CH<sub>2</sub>F<sub>2</sub> 38,1110 %; C<sub>2</sub>H<sub>F</sub><sub>5</sub> 17,9557 %; C<sub>2</sub>H<sub>2</sub>F<sub>4</sub> 43,9332 %**

Issue Date: 12.11.2014  
Last revised date: 09.11.2023

Version: 3.0

SDS No.: 000010022600  
2/18



**Signal Word:** Warning

**Hazard Statement(s):** H280: Contains gas under pressure; may explode if heated.

**Precautionary Statements**

**General** None.

**Prevention:** None.

**Response:** None.

**Storage:** P403: Store in a well-ventilated place.

**Disposal** None.

**Supplemental information**

EIGA-0783: Contains fluorinated greenhouse gases  
EIGA-As: Asphyxiant in high concentrations.

**2.3 Other hazards** Contact with evaporating liquid may cause frostbite or freezing of skin.

**SECTION 3: Composition/information on ingredients**

**3.2 Mixtures**

Chemical name	Chemical formula	Concentration	CAS-No.	REACH Registration No.	M-Factor:	Notes
Pentafluoroethane	C <sub>2</sub> H <sub>F</sub> <sub>5</sub>	17.9557%	354-33-6	01-2119485636-25	-	
Difluoromethane	CH <sub>2</sub> F <sub>2</sub>	38.1110%	75-10-5	01-2119471312-47	-	
Norflurane	C <sub>2</sub> H <sub>2</sub> F <sub>4</sub>	43.9332%	811-97-2	01-2119459374-33	-	

The concentrations of the components in the SDS header, product name on page one and in section 3.2 are in mol due to regulatory requirements. All concentrations are nominal.

SDS\_GB



## SAFETY DATA SHEET

According to Regulation (EC) No. 1907/2006 (REACH) Article 31, Annex II as amended

**CH<sub>2</sub>F<sub>2</sub> 38,1110 %;C<sub>2</sub>H<sub>2</sub>F<sub>5</sub> 17,9557 %;C<sub>2</sub>H<sub>2</sub>F<sub>4</sub> 43,9332 %**

Issue Date: 12.11.2014

Version: 3.0

SDS No.: 000010022600

Last revised date: 09.11.2023

3/18

# This substance has workplace exposure limit(s).  
PBT: persistent, bioaccumulative and toxic substance.  
vPvB: very persistent and very bioaccumulative substance.

### Classification

Chemical name	Classification		Notes
Pentafluoroethane	CLP:	Press. Gas Liquef. Gas;H280	
Difluoromethane	CLP:	Flam. Gas 1A;H220, Press. Gas Liquef. Gas;H280	
Norflurane	CLP:	Press. Gas Liquef. Gas;H280	

CLP: Regulation No. 1272/2008.

The full text for all H-statements is displayed in section 16.

## SECTION 4: First aid measures

**General:** In high concentrations may cause asphyxiation. Symptoms may include loss of mobility/consciousness. Victim may not be aware of asphyxiation. Remove victim to uncontaminated area wearing self contained breathing apparatus. Keep victim warm and rested. Call a doctor. Apply artificial respiration if breathing stopped.

### 4.1 Description of first aid measures

**Inhalation:** In high concentrations may cause asphyxiation. Symptoms may include loss of mobility/consciousness. Victim may not be aware of asphyxiation. Remove victim to uncontaminated area wearing self contained breathing apparatus. Keep victim warm and rested. Call a doctor. Apply artificial respiration if breathing stopped.

**Eye contact:** Rinse the eye with water immediately. Remove contact lenses, if present and easy to do. Continue rinsing. Flush thoroughly with water for at least 15 minutes. Get immediate medical assistance. If medical assistance is not immediately available, flush an additional 15 minutes.

**Skin Contact:** Contact with evaporating liquid may cause frostbite or freezing of skin.

**Ingestion:** Ingestion is not considered a potential route of exposure.

**4.2 Most important symptoms and effects, both acute and delayed:** Respiratory arrest. Contact with liquefied gas can cause damage (frostbite) due to rapid evaporative cooling.

### 4.3 Indication of any immediate medical attention and special treatment needed

**Hazards:** Respiratory arrest. Contact with liquefied gas can cause damage (frostbite) due to rapid evaporative cooling.

SDS\_GB

**SAFETY DATA SHEET**

According to Regulation (EC) No. 1907/2006 (REACH) Article 31, Annex II as amended

**CH<sub>2</sub>F<sub>2</sub> 38,1110 %;C<sub>2</sub>H<sub>5</sub>F 17,9557 %;C<sub>2</sub>H<sub>2</sub>F<sub>4</sub> 43,9332 %**

Issue Date:	12.11.2014	Version: 3.0	SDS No.: 000010022600
Last revised date:	09.11.2023		4/18

**Treatment:** Thaw frosted parts with lukewarm water. Do not rub affected area. Get immediate medical advice/attention.

**SECTION 5: Firefighting measures**

**General Fire Hazards:** Heat may cause the containers to explode.

**5.1 Extinguishing media**

**Suitable extinguishing media:** Material will not burn. In case of fire in the surroundings: use appropriate extinguishing agent. Water spray, fog, CO<sub>2</sub>, dry chemical, or alcohol resistant foam.

**Unsuitable extinguishing media:** None.

**5.2 Special hazards arising from the substance or mixture:** Fire or excessive heat may produce hazardous decomposition products.

**Hazardous Combustion Products:** If involved in a fire the following toxic and/or corrosive fumes may be produced by thermal decomposition: Carbon oxides fluorocarbons Hydrogen fluoride ; Carbonyl difluoride

**5.3 Advice for firefighters**

**Special fire-fighting procedures:** In case of fire: Stop leak if safe to do so. Continue water spray from protected position until container stays cool. Use extinguishants to contain the fire. Isolate the source of the fire or let it burn out.

**Special protective equipment for fire-fighters:** Firefighters must use standard protective equipment including flame retardant coat, helmet with face shield, gloves, rubber boots, and in enclosed spaces, SCBA. Guideline: EN 469 Protective clothing for firefighters. Performance requirements for protective clothing for firefighting. EN 15090 Footwear for firefighters. EN 659 Protective gloves for firefighters. EN 443 Helmets for fire fighting in buildings and other structures. EN 137 Respiratory protective devices - Self-contained open-circuit compressed air breathing apparatus with full face mask - Requirements, testing, marking.

**SECTION 6: Accidental release measures**

**6.1 Personal precautions, protective equipment and emergency procedures:** Evacuate area. Provide adequate ventilation. Prevent from entering sewers, basements and workpits, or any place where its accumulation can be dangerous. Wear self-contained breathing apparatus when entering area unless atmosphere is proved to be safe. EN 137 Respiratory protective devices - Self-contained open-circuit compressed air breathing apparatus with full face mask - Requirements, testing, marking.

SDS\_GB

## SAFETY DATA SHEET

According to Regulation (EC) No. 1907/2006 (REACH) Article 31, Annex II as amended

**CH<sub>2</sub>F<sub>2</sub> 38,1110 %;C<sub>2</sub>H<sub>2</sub>F<sub>4</sub> 43,9332 %**

Issue Date: 12.11.2014 Version: 3.0 SDS No.: 000010022600  
Last revised date: 09.11.2023 5/18

6.2 Environmental Precautions: Prevent further leakage or spillage if safe to do so.

6.3 Methods and material for containment and cleaning up: Provide adequate ventilation.

6.4 Reference to other sections: Refer to sections 8 and 13.

### SECTION 7: Handling and storage:

7.1 Precautions for safe handling: Only experienced and properly instructed persons should handle gases under pressure. Use only properly specified equipment which is suitable for this product, its supply pressure and temperature. Refer to supplier's handling instructions. The substance must be handled in accordance with good industrial hygiene and safety procedures. Protect containers from physical damage; do not drag, roll, slide or drop. Do not remove or deface labels provided by the supplier for the identification of the container contents. When moving containers, even for short distances, use appropriate equipment eg. trolley, hand truck, fork truck etc. Secure cylinders in an upright position at all times, close all valves when not in use. Provide adequate ventilation. Suck back of water into the container must be prevented. Do not allow backfeed into the container. Avoid suckback of water, acid and alkalis. Keep container below 50°C in a well ventilated place. Observe all regulations and local requirements regarding storage of containers. When using do not eat, drink or smoke. Store in accordance with local/regional/national/international regulations. Never use direct flame or electrical heating devices to raise the pressure of a container. Leave valve protection caps in place until the container has been secured against either a wall or bench or placed in a container stand and is ready for use. Damaged valves should be reported immediately to the supplier. Close container valve after each use and when empty, even if still connected to equipment. Never attempt to repair or modify container valves or safety relief devices. Replace valve outlet caps or plugs and container caps where supplied as soon as container is disconnected from equipment. Keep container valve outlets clean and free from contaminants particularly oil and water. If user experiences any difficulty operating container valve discontinue use and contact supplier. Never attempt to transfer gases from one container to another. Container valve guards or caps should be in place.

7.2 Conditions for safe storage, including any incompatibilities: Containers should not be stored in conditions likely to encourage corrosion. Stored containers should be periodically checked for general conditions and leakage. Container valve guards or caps should be in place. Store containers in location free from fire risk and away from sources of heat and ignition. Keep away from combustible material.

7.3 Specific end use(s): None.

SDS\_GB

**SAFETY DATA SHEET**

According to Regulation (EC) No. 1907/2006 (REACH) Article 31, Annex II as amended

**CH<sub>2</sub>F<sub>2</sub> 38,1110 %;C<sub>2</sub>H<sub>2</sub>F<sub>5</sub> 17,9557 %;C<sub>2</sub>H<sub>2</sub>F<sub>4</sub> 43,9332 %**

Issue Date: 12.11.2014  
Last revised date: 09.11.2023

Version: 3.0

SDS No.: 000010022600  
6/18

**SECTION 8: Exposure controls/personal protection**

**8.1 Control Parameters**

**Occupational Exposure Limits**

None of the components have assigned exposure limits.

**DNEL-Values**

Critical component	Type	Value	Remarks
Pentafluoroethane	Workers - Inhalation, Systemic, long-term	16444 mg/m <sup>3</sup>	Repeated dose toxicity
	Workers - Inhalation, Systemic, short-term		Low hazard (no threshold derived)
	Workers - Inhalation, Local, long-term, Local, short-term		Low hazard (no threshold derived)
	Workers - Oral, Systemic, long-term, Systemic, short-term		Low hazard (no threshold derived)
	Workers - Oral, Local, long-term, Local, short-term		Low hazard (no threshold derived)
	Workers - Eyes, Local effect		Low hazard (no threshold derived)
Difluoromethane	Workers - Inhalation, Systemic, long-term	7035 mg/m <sup>3</sup>	Repeated dose toxicity
Norflurane	Workers - Inhalation, Systemic, long-term	13936 mg/m <sup>3</sup>	Repeated dose toxicity

**PNEC-Values**

Critical component	Type	Value	Remarks
Pentafluoroethane	Aquatic (freshwater)	0.1 mg/l	-
Pentafluoroethane	Sediment (freshwater)	0.6 mg/kg	-
Difluoromethane	Aquatic (freshwater)	0.313 mg/l	-
Difluoromethane	Sediment (freshwater)	1.807 mg/kg	-
Norflurane	Aquatic (marine water)	0.01 mg/l	-
Norflurane	Sewage treatment plant	73 mg/l	-
Norflurane	Sediment (freshwater)	0.75 mg/kg	-
Norflurane	Aquatic (freshwater)	0.1 mg/l	-

SDS\_GB

## SAFETY DATA SHEET

According to Regulation (EC) No. 1907/2006 (REACH) Article 31, Annex II as amended

**CH<sub>2</sub>F<sub>2</sub> 38,1110 %;C<sub>2</sub>H<sub>F</sub>5 17,9557 %;C<sub>2</sub>H<sub>2</sub>F<sub>4</sub> 43,9332 %**

Issue Date: 12.11.2014

Version: 3.0

SDS No.: 000010022600

Last revised date: 09.11.2023

7/18

### 8.2 Exposure controls

#### Appropriate engineering controls:

Consider a work permit system e.g. for maintenance activities. Ensure adequate air ventilation. Oxygen detectors should be used when asphyxiating gases may be released. Provide adequate ventilation, including appropriate local extraction, to ensure that the defined occupational exposure limit is not exceeded. Systems under pressure should be regularly checked for leakages. Preferably use permanent leak tight connections (eg. welded pipes). Do not eat, drink or smoke when using the product.

#### Individual protection measures, such as personal protective equipment

##### General information:

A risk assessment should be conducted and documented in each work area to assess the risks related to the use of the product and to select the PPE that matches the relevant risk. The following recommendations should be considered. Keep self contained breathing apparatus readily available for emergency use. Personal protective equipment for the body should be selected based on the task being performed and the risks involved.

##### Eye/face protection:

Safety eyewear, goggles or face-shield to EN166 should be used to avoid exposure to liquid splashes. Wear eye protection to EN 166 when using gases. Guideline: EN 166 Personal Eye Protection.

##### Skin protection

###### Hand Protection:

Guideline: EN 388 Protective gloves against mechanical risks.  
Additional Information: Wear working gloves while handling containers

###### Body protection:

No special precautions.

###### Other:

Wear safety shoes while handling containers  
Guideline: ISO 20345 Personal protective equipment - Safety footwear.

##### Respiratory Protection:

Not required.

##### Thermal hazards:

No precautionary measures are necessary.

##### Hygiene measures:

Specific risk management measures are not required beyond good industrial hygiene and safety procedures. Do not eat, drink or smoke when using the product.

#### Environmental exposure controls:

For waste disposal, see section 13 of the SDS.

SDS\_GB

**SAFETY DATA SHEET**

According to Regulation (EC) No. 1907/2006 (REACH) Article 31, Annex II as amended

**CH<sub>2</sub>F<sub>2</sub> 38,1110 %;C<sub>2</sub>H<sub>F</sub><sub>5</sub> 17,9557 %;C<sub>2</sub>H<sub>2</sub>F<sub>4</sub> 43,9332 %**

Issue Date: 12.11.2014  
Last revised date: 09.11.2023

Version: 3.0

SDS No.: 000010022600  
8/18

**SECTION 9: Physical and chemical properties**

**9.1 Information on basic physical and chemical properties**

**Appearance**

Physical state: Gas  
Form: Liquefied gas  
Color: C<sub>2</sub>H<sub>F</sub><sub>5</sub>: Colorless  
CH<sub>2</sub>F<sub>2</sub>: Colorless  
C<sub>2</sub>H<sub>2</sub>F<sub>4</sub>: Colorless

Odor: C<sub>2</sub>H<sub>F</sub><sub>5</sub>: faint ethereal  
CH<sub>2</sub>F<sub>2</sub>: Odorless  
C<sub>2</sub>H<sub>2</sub>F<sub>4</sub>: faint ethereal

Odor Threshold: Odor threshold is subjective and is inadequate to warn of over exposure.

pH: Not applicable.

Melting Point: No data available.

Boiling Point: -43.6 °C

Sublimation Point: Not applicable.

Critical Temp. (°C): 86.74 °C

Flash Point: Not applicable to gases and gas mixtures.

Evaporation Rate: Not applicable to gases and gas mixtures.

Flammability (solid, gas): Non-Flammable Gas

Flammability Limit - Upper (%): Not applicable.

Flammability Limit - Lower (%): 45.41 %(V) (Calculated value)

Vapor pressure: 1,190.3 kPa (25 °C)

Relative vapor density: 3.03 (calculated) (15 °C)

Relative density: No data available.

**Solubility(ies)**

Solubility in Water: No data available.

Partition coefficient (n-octanol/water): Not known.

Autoignition Temperature: Not applicable.

Decomposition Temperature: Not known.

**Viscosity**

Kinematic viscosity: No data available.

Dynamic viscosity: No data available.

Explosive properties: Not applicable.

Oxidizing properties: Not applicable.

**9.2 Other information:**

Gas/vapour heavier than air. May accumulate in confined

SDS\_GB

**SAFETY DATA SHEET**

According to Regulation (EC) No. 1907/2006 (REACH) Article 31, Annex II as amended

**CH2F2 38,1110 %;C2HF5 17,9557 %;C2H2F4 43,9332 %**

Issue Date:	12.11.2014	Version: 3.0	SDS No.: 000010022600
Last revised date:	09.11.2023		9/18

spaces, particularly at or below ground level.

**SECTION 10: Stability and reactivity**

<b>10.1 Reactivity:</b>	No reactivity hazard other than the effects described in sub-section below.
<b>10.2 Chemical Stability:</b>	Stable under normal conditions.
<b>10.3 Possibility of hazardous reactions:</b>	None.
<b>10.4 Conditions to avoid:</b>	Open flames and high energy ignition sources. The product is not flammable in air under ambient conditions of temperature and pressure. When pressurised with air or oxygen, the mixture may become flammable. Certain mixtures of HCFCs or HFCs with chlorine may become flammable or reactive under certain conditions.
<b>10.5 Incompatible Materials:</b>	No reaction with any common materials in dry or wet conditions. Alkali metals. Alkali earth metals. Chemically-active metals (such as calcium, powdered aluminum, zinc, and magnesium)
<b>10.6 Hazardous Decomposition Products:</b>	Under normal conditions of storage and use, hazardous decomposition products should not be produced.

**SECTION 11: Toxicological information**

**General information:** None.

**11.1 Information on toxicological effects**

**Acute toxicity - Oral Product** Based on available data, the classification criteria are not met.

**Acute toxicity - Dermal Product** Based on available data, the classification criteria are not met.

**Acute toxicity - Inhalation Product** Based on available data, the classification criteria are not met.

**Component Information**  
Pentafluoroethane

LC Lo (Sprague-Dawley rat, Female, Male, 4 h): > 800000 ppm (OECD Guideline 403 (Acute Inhalation Toxicity)) Remarks: Experimental result, Key study 1 = reliable without restrictions

SDS\_GB

**SAFETY DATA SHEET**

According to Regulation (EC) No. 1907/2006 (REACH) Article 31, Annex II as amended

**CH<sub>2</sub>F<sub>2</sub> 38,1110 %;C<sub>2</sub>H<sub>5</sub>F 17,9557 %;C<sub>2</sub>H<sub>2</sub>F<sub>4</sub> 43,9332 %**

Issue Date:	12.11.2014	Version: 3.0	SDS No.: 000010022600
Last revised date:	09.11.2023		10/18

	ALC (Sprague-Dawley rat, Male, 4 h): > 709000 ppm Remarks: Experimental result, Supporting study 1 = reliable without restrictions
Difluoromethane	LC 0 (Wistar rat, Female, Male, 4 h): > 520000 ppm (OECD Guideline 403 (Acute Inhalation Toxicity)) Remarks: Inhalation; vapor Experimental result, Key study
<b>Repeated dose toxicity</b>	
<b>Component Information</b>	
Pentafluoroethane	NOAEL (Rat(Female, Male), Inhalation, 13 Weeks): >= 50,000 ppm(m) Inhalation Experimental result, Key study
Difluoromethane	NOAEL (Wistar-derived rat(Female, Male), Inhalation, 28 d): 49,500 ppm(m) Inhalation Experimental result, Supporting study NOAEL (Wistar-derived rat(Female, Male), Inhalation, 13 Weeks): 49,100 ppm(m) Inhalation Experimental result, Key study
Norflurane	NOAEL (Rat(Female, Male), Inhalation, 2 yr): 50,000 ppm(m) Inhalation Experimental result, Key study
<b>Skin Corrosion/Irritation</b>	
<b>Product</b>	Based on available data, the classification criteria are not met.
<b>Serious Eye Damage/Eye Irritation</b>	
<b>Product</b>	Based on available data, the classification criteria are not met.
<b>Respiratory or Skin Sensitization</b>	
<b>Product</b>	Based on available data, the classification criteria are not met.
<b>Germ Cell Mutagenicity</b>	
<b>Product</b>	Based on available data, the classification criteria are not met.
<b>In vitro</b>	
<b>Component Information</b>	
Pentafluoroethane	Chromosome aberration (OECD Guideline 473 (In Vitro Mammalian Chromosome Aberration Test)): Negative. Ames test in vitro: (OECD Guideline 471 (Bacterial Reverse Mutation Test)): Negative.
Difluoromethane	Ames test in vitro: (OECD Guideline 471 (Bacterial Reverse Mutation Test)): Negative. Chromosome aberration (OECD Guideline 473 (In Vitro Mammalian Chromosome Aberration Test)): Negative. In vitro gene mutations test on mammalian cells: Negative.

SDS\_GB



**SAFETY DATA SHEET**

According to Regulation (EC) No. 1907/2006 (REACH) Article 31, Annex II as amended

**CH2F2 38,1110 %;C2HF5 17,9557 %;C2H2F4 43,9332 %**

Issue Date:	12.11.2014	Version: 3.0	SDS No.: 000010022600
Last revised date:	09.11.2023		11/18

**In vivo**

**Component Information**

Pentafluoroethane	Micronucleus test in vivo mouse: (OECD Guideline 474 (Mammalian Erythrocyte Micronucleus Test)) Inhalation (Mouse): Negative.
Difluoromethane	Micronucleus test in vivo mouse: (OECD Guideline 474 (Mammalian Erythrocyte Micronucleus Test)) (Mouse): Negative.

**Carcinogenicity**

**Product**

Based on available data, the classification criteria are not met.

**Reproductive toxicity**

**Product**

Based on available data, the classification criteria are not met.

**Developmental toxicity (Teratogenicity)**

**Component Information**

Difluoromethane	Rabbit (Female) Inhalation (OECD Guideline 414 (Prenatal Developmental Toxicity Study))
-----------------	---

**Specific Target Organ Toxicity - Single Exposure**

**Product**

Based on available data, the classification criteria are not met.

**Specific Target Organ Toxicity - Repeated Exposure**

**Product**

Based on available data, the classification criteria are not met.

**Aspiration Hazard**

**Product**

Not applicable to gases and gas mixtures..

**SECTION 12: Ecological information**

General information: Not applicable

**12.1 Toxicity**

**Acute toxicity**

**Product**

No ecological damage caused by this product.

**Acute toxicity - Fish**

**Component Information**

Pentafluoroethane	LC 50 (Oncorhynchus mykiss, 96 h): 450 mg/l (semi-static) Remarks: Read-across from supporting substance (structural analogue or surrogate), Weight of Evidence study 1 = reliable without restrictions
Difluoromethane	LC 50 (Fish (freshwater), 96 h): 1,731 mg/l Remarks: QSAR, Key study 2 = reliable with restrictions

SDS\_GB

**SAFETY DATA SHEET**

According to Regulation (EC) No. 1907/2006 (REACH) Article 31, Annex II as amended

**CH<sub>2</sub>F<sub>2</sub> 38,1110 %;C<sub>2</sub>H<sub>2</sub>F<sub>4</sub> 43,9332 %**

Issue Date:	12.11.2014	Version: 3.0	SDS No.: 000010022600
Last revised date:	09.11.2023		12/18

Norflurane	LC 50 (Oncorhynchus mykiss, 96 h): 450 mg/l (semi-static) Remarks: Experimental result, Key study
------------	---

**Acute toxicity - Aquatic Invertebrates**

**Component Information**

Pentafluoroethane	EC 50 (Daphnia magna, 48 h): > 200 mg/l (Static) Remarks: Read-across from supporting substance (structural analogue or surrogate), Weight of Evidence study 2 = reliable with restrictions
Difluoromethane	EC 50 (Daphnid, 48 h): 652 mg/l Remarks: QSAR, Key study 2 = reliable with restrictions LC 50 (Daphnid, 48 h): 833 mg/l Remarks: QSAR, Key study 2 = reliable with restrictions
Norflurane	EC 50 (Daphnia magna, 24 h): 960 mg/l (Static) Remarks: Experimental result, Key study

**Toxicity to microorganisms**

**Component Information**

Difluoromethane	Static EC 50 (Algae (Pseudokirchneriella subcapitata), 72 h): > 118 mg/l (OECD Guideline 201 (Freshwater Alga and Cyanobacteria, Growth Inhibition Test)) EC 50 (Alga, 96 h): 313 mg/l (estimated)
-----------------	---

**Chronic Toxicity - Fish**

**Component Information**

Pentafluoroethane	NOEC (30 d): 32 mg/l QSAR
Difluoromethane	NOEC (Danio rerio; Pimephales promelas, 30 d): 169 mg/l QSAR, Supporting study 4 = not assignable

**Chronic Toxicity - Aquatic Invertebrates**

**Component Information**

Pentafluoroethane	EC 50 (16 d): 12 mg/l
-------------------	-----------------------

**Toxicity to Aquatic Plants**

**Component Information**

Pentafluoroethane	EC 50 (Green Algae, 72 h): 142 mg/l
Difluoromethane	EC 50 (Alga, 96 h): 142 mg/l

**SAFETY DATA SHEET**

According to Regulation (EC) No. 1907/2006 (REACH) Article 31, Annex II as amended

**CH<sub>2</sub>F<sub>2</sub> 38,1110 %;C<sub>2</sub>H<sub>F</sub><sub>5</sub> 17,9557 %;C<sub>2</sub>H<sub>2</sub>F<sub>4</sub> 43,9332 %**

Issue Date:	12.11.2014	Version: 3.0	SDS No.: 000010022600
Last revised date:	09.11.2023		13/18

**12.2 Persistence and Degradability**

**Product** Not applicable to gases and gas mixtures..

**Biodegradation**

**Component Information**

Pentafluoroethane	5 % (28 d) Detected in water. Experimental result, Key study
Difluoromethane	5 % (28 d) Detected in water. Experimental result, Key study
Norflurane	3 % (28 d) Detected in water. Experimental result, Key study

**12.3 Bioaccumulative potential**

**Product** The subject product is expected to biodegrade and is not expected to persist for long periods in an aquatic environment.

**12.4 Mobility in soil**

**Product** Because of its high volatility, the product is unlikely to cause ground or water pollution.

**12.5 Results of PBT and vPvB assessment**

**Product** Not classified as PBT or vPvB.

**12.6 Other adverse effects:**

**Global Warming Potential**

Global warming potential: 1,774  
Contains fluorinated greenhouse gases When discharged in large quantities may contribute to the greenhouse effect. For GWP value of mixture and quantities, refer to container label.

**Component Information**

Pentafluoroethane	<u><a href="#">EU. F-Gases Subject to Emission Limits/Reporting (Annexes I, II), Regulation 517/2014/EU on FGGs</a></u> - Global warming potential: 3500 Annex 1: Fluorinated greenhouse gases referred to in Point 1 of Article 2; Section 1:Hydrofluorocarbons (HFCs) and its mixtures
Difluoromethane	<u><a href="#">EU. F-Gases Subject to Emission Limits/Reporting (Annexes I, II), Regulation 517/2014/EU on FGGs</a></u> - Global warming potential: 675 Annex 1: Fluorinated greenhouse gases referred to in Point 1 of Article 2; Section 1:Hydrofluorocarbons (HFCs) and its mixtures
Norflurane	<u><a href="#">EU. F-Gases Subject to Emission Limits/Reporting (Annexes I, II), Regulation 517/2014/EU on FGGs</a></u>

SDS\_GB

**SAFETY DATA SHEET**

According to Regulation (EC) No. 1907/2006 (REACH) Article 31, Annex II as amended

**CH2F2 38,1110 %;C2HF5 17,9557 %;C2H2F4 43,9332 %**

Issue Date:	12.11.2014	Version: 3.0	SDS No.: 000010022600
Last revised date:	09.11.2023		14/18

- Global warming potential: 1430 Annex 1: Fluorinated greenhouse gases referred to in Point 1 of Article 2; Section 1: Hydrofluorocarbons (HFCs) and its mixtures

**SECTION 13: Disposal considerations**

**13.1 Waste treatment methods**

**General information:** Avoid discharges to atmosphere. Do not discharge into any place where its accumulation could be dangerous. Refer to manufacturer or supplier for information on recovery or recycling.

**Disposal methods:** Refer to the EIGA code of practice (Doc.30 "Disposal of Gases", downloadable at <http://www.eiga.org>) for more guidance on suitable disposal methods. Dispose of container via supplier only. Discharge, treatment, or disposal may be subject to national, state, or local laws.

European Waste Codes  
**Container:** 14 06 01\*: chlorofluorocarbons, HCFC, HFC

**SECTION 14: Transport information**

**ADR**

14.1 UN number or ID number:	UN 3340
14.2 UN Proper Shipping Name:	REFRIGERANT GAS R 407C(1,1,1,2-Tetrafluoroethane, Pentafluoroethane)
14.3 Transport Hazard Class(es)	
Class:	2
Label(s):	2.2
Hazard No. (ADR):	20
Tunnel restriction code:	(C/E)
Emergency Action Code:	2TE
14.4 Packing Group:	-
14.5 Environmental hazards:	Not applicable
14.6 Special precautions for user:	-

SDS\_GB

**SAFETY DATA SHEET**

According to Regulation (EC) No. 1907/2006 (REACH) Article 31, Annex II as amended

**CH2F2 38,1110 %;C2HF5 17,9557 %;C2H2F4 43,9332 %**

Issue Date:	12.11.2014	Version: 3.0	SDS No.: 000010022600
Last revised date:	09.11.2023		15/18

**RID**

14.1 UN number or ID number:	UN 3340
14.2 UN Proper Shipping Name:	REFRIGERANT GAS R 407C(1,1,1,2-Tetrafluoroethane, Pentafluoroethane)
14.3 Transport Hazard Class(es)	
Class:	2
Label(s):	2.2
14.4 Packing Group:	-
14.5 Environmental hazards:	Not applicable
14.6 Special precautions for user:	-

**IMDG**

14.1 UN number or ID number:	UN 3340
14.2 UN Proper Shipping Name:	REFRIGERANT GAS R 407C(1,1,1,2-Tetrafluoroethane, Pentafluoroethane)
14.3 Transport Hazard Class(es)	
Class:	2.2
Label(s):	2.2
EmS No.:	F-C, S-V
14.4 Packing Group:	-
14.5 Environmental hazards:	Not applicable
14.6 Special precautions for user:	-

**IATA**

14.1 UN number or ID number:	UN 3340
14.2 Proper Shipping Name:	Refrigerant gas R 407C(1,1,1,2-Tetrafluoroethane, Pentafluoroethane)
14.3 Transport Hazard Class(es):	
Class:	2.2
Label(s):	2.2
14.4 Packing Group:	-
14.5 Environmental hazards:	Not applicable
14.6 Special precautions for user:	-
Other information	
Passenger and cargo aircraft:	Allowed.
Cargo aircraft only:	Allowed.

14.7 Transport in bulk according to Annex II of MARPOL and the IBC Code: Not applicable

SDS\_GB

## SAFETY DATA SHEET

According to Regulation (EC) No. 1907/2006 (REACH) Article 31, Annex II as amended

**CH<sub>2</sub>F<sub>2</sub> 38,1110 %;C<sub>2</sub>H<sub>5</sub>F 17,9557 %;C<sub>2</sub>H<sub>2</sub>F<sub>4</sub> 43,9332 %**

Issue Date: 12.11.2014

Version: 3.0

SDS No.: 000010022600

Last revised date: 09.11.2023

16/18

### Additional identification:

Avoid transport on vehicles where the load space is not separated from the driver's compartment. Ensure vehicle driver is aware of the potential hazards of the load and knows what to do in the event of an accident or an emergency. Before transporting product containers ensure that they are firmly secured. Ensure that the container valve is closed and not leaking. Container valve guards or caps should be in place. Ensure adequate air ventilation.

## SECTION 15: Regulatory information

### 15.1 Safety, health and environmental regulations/legislation specific for the substance or mixture:

EU. Directive 2012/18/EU (SEVESO III) on major accident hazards involving dangerous substances, Annex I: Not applicable

#### National Regulations

Dangerous Substances and Explosive Atmospheres Regulations (DSEAR 2002 No. 2776). Management of Health and Safety at Work Regulations (1999 No. 3242). The Regulatory Reform (Fire Safety) Order 2005 (2005 No. 1541). Control of Substances Hazardous to Health Regulations (COSHH, 2002 No. 2677). Provision and Use of Work Equipment Regulations (PUWER, 1998 No. 2306). Personal Protective Equipment Regulations (1992 No. 2966). Control of Major Accident Hazards Regulations (COMAH, 2015 No. 483). Pressure Systems Safety Regulations (PSSR, 2000 No. 128). Only products that comply with the food regulations (EC) No. 1333/2008 and (EU) No. 231/2012 and are labelled as such may be used as food additives. This Safety Data Sheet has been produced to comply with Regulation (EU) 2015/830.

**15.2 Chemical safety assessment:** No Chemical Safety Assessment has been carried out.

## SECTION 16: Other information

### Revision Information:

Relevant changes are indicated using two vertical bold lines and red text, the text is also highlighted in grey.

**SAFETY DATA SHEET**

According to Regulation (EC) No. 1907/2006 (REACH) Article 31, Annex II as amended

**CH2F2 38,1110 %;C2HF5 17,9557 %;C2H2F4 43,9332 %**

Issue Date: 12.11.2014 Version: 3.0 SDS No.: 000010022600  
 Last revised date: 09.11.2023 17/18

**Key literature references and sources for data:**

Various sources of data have been used in the compilation of this SDS, they include but are not exclusive to:  
 Agency for Toxic Substances and Diseases Registry (ATSDR) (<http://www.atsdr.cdc.gov/>).  
 European Chemical Agency: Guidance on the Compilation of Safety Data Sheets.  
 European Chemical Agency: Information on Registered Substances <http://apps.echa.europa.eu/registered/registered-sub.aspx#search>  
 European Industrial Gases Association (EIGA) Doc. 169 "Classification and Labelling guide", as amended.  
 International Programme on Chemical Safety (<http://www.inchem.org/>)  
 ISO 10156:2010 Gases and gas mixtures - Determination of fire potential and oxidizing ability for the selection of cylinder valve outlets.  
 Matheson Gas Data Book, 7th Edition.  
 National Institute for Standards and Technology (NIST) Standard Reference Database Number 69.  
 The ESIS (European chemical Substances Information System) platform of the former European Chemicals Bureau (ECB) ESIS (<http://ecb.jrc.ec.europa.eu/esis/>).  
 The European Chemical Industry Council (CEFIC) ERICards.  
 United States of America's National Library of Medicine's toxicology data network TOXNET (<http://toxnet.nlm.nih.gov/index.html>)  
 Threshold Limit Values (TLV) from the American Conference of Governmental Industrial Hygienists (ACGIH).  
 Substance specific information from suppliers.  
 Details given in this document are believed to be correct at the time of publication.  
 Code of Practice for the Safety, Health and Welfare at Work (Chemical Agents) Regulations and the Safety, Health and Welfare at Work (Carcinogens) Regulations, as amended

**Classification and procedure used to derive the classification for mixtures according to Regulation (EC) 1272/2008 [CLP]**

Classification according to Regulation (EC) No 1272/2008 as amended.	Classification procedure
Gases under pressure, Liquefied gas	On basis of test data

**Wording of the H-statements in section 2 and 3**

H220	Extremely flammable gas.
H280	Contains gas under pressure; may explode if heated.

**Training information:**

Users of breathing apparatus must be trained. The hazard of asphyxiation is often overlooked and must be stressed during operator training. Ensure operators understand the hazards.

SDS\_GB

**SAFETY DATA SHEET**

According to Regulation (EC) No. 1907/2006 (REACH) Article 31, Annex II as amended

**CH<sub>2</sub>F<sub>2</sub> 38,1110 %;C<sub>2</sub>H<sub>F</sub><sub>5</sub> 17,9557 %;C<sub>2</sub>H<sub>2</sub>F<sub>4</sub> 43,9332 %**

Issue Date:	12.11.2014	Version: 3.0	SDS No.: 000010022600
Last revised date:	09.11.2023		18/18

**Classification according to Regulation (EC) No 1272/2008 as amended.**

Press. Gas Liq. Gas, H280

**Other information:**

Before using this product in any new process or experiment, a thorough material compatibility and safety study should be carried out. Ensure adequate air ventilation. Ensure all national/local regulations are observed. Whilst proper care has been taken in the preparation of this document, no liability for injury or damage resulting from its use can be accepted. Note: When the Product Name appears in the SDS header the decimal sign and its position comply with rules for the structure and drafting of international standards, and is a comma on the line. As an example 2,000 is two (to three decimal places) and not two thousand, whilst 1.000 is one thousand and not one (to three decimal places).

**Last revised date:**

09.11.2023

**Disclaimer:**

This information is provided without warranty. The information is believed to be correct. This information should be used to make an independent determination of the methods to safeguard workers and the environment.









**SAFETY DATA SHEET**  
according to Regulation (EC) No. 1907/2006  
Valvoline™ OEM ADVANCED AFC 48 RTU  
Coolant

Version: 5.0

Revision Date: 27.07.2023

Print Date: 17/07/2024

---

## SECTION 1: Identification of the substance/mixture and of the company/undertaking

### 1.1 Product identifier

Trade name : Valvoline™ OEM ADVANCED AFC 48 RTU  
Coolant

Product code : 892099

Unique Formula Identifier (UFI) : P4TD-5JNU-J60W-S17A

### 1.2 Relevant identified uses of the substance or mixture and uses advised against

Use of the substance/mixture : Coolant and antifreeze.

### 1.3 Details of the supplier of the safety data sheet

Company : Ellis Enterprises B.V., an affiliate of Valvoline Global  
Operations  
Wieldrechtseweg 39  
3316 BG Dordrecht  
Netherlands

Telephone : +31 (0)78 654 3500 (in the Netherlands), or contact your local  
CSR contact person

E-mail address of person responsible for the SDS : SDS@valvolineglobal.com

### 1.4 Emergency telephone number

00-800-825-8654, or contact your local emergency telephone number at 112

---

## SECTION 2: Hazards identification

### 2.1 Classification of the substance or mixture

**Classification (REGULATION (EC) No 1272/2008) as amended by GB-CLP Regulation, UK SI 2019/720, and UK SI 2020/1567)**

Acute toxicity, Category 4

H302: Harmful if swallowed.



**SAFETY DATA SHEET**  
according to Regulation (EC) No. 1907/2006  
Valvoline™ OEM ADVANCED AFC 48 RTU  
Coolant

Version: 5.0

Revision Date: 27.07.2023

Print Date: 17/07/2024

Specific target organ toxicity - repeated exposure, Category 2, Kidney, Liver

H373: May cause damage to organs through prolonged or repeated exposure if swallowed.

## 2.2 Label elements

Labelling (REGULATION (EC) No 1272/2008) as amended by GB-CLP Regulation, UK SI 2019/720, and UK SI 2020/1567)

Hazard pictograms



Signal word

: Warning

Hazard statements

: H302 Harmful if swallowed.  
H373 May cause damage to organs (Kidney, Liver) through prolonged or repeated exposure if swallowed.

Precautionary statements

: **Prevention:**  
P260 Do not breathe mist or vapours.  
P264 Wash skin thoroughly after handling.  
P270 Do not eat, drink or smoke when using this product.  
**Response:**  
P301 + P312 + P330 IF SWALLOWED: Call a POISON CENTER/ doctor if you feel unwell. Rinse mouth.  
P314 Get medical advice/ attention if you feel unwell.  
**Disposal:**  
P501 Dispose of contents/ container to an approved waste disposal plant.

Hazardous components which must be listed on the label:

ETHYLENE GLYCOL

## 2.3 Other hazards

This substance/mixture contains no components considered to be either persistent, bioaccumulative and toxic (PBT), or very persistent and very bioaccumulative (vPvB) at levels of 0.1% or higher.

## SECTION 3: Composition/information on ingredients

### 3.2 Mixtures

#### Components

Chemical name	CAS-No.	Classification	Concentration
---------------	---------	----------------	---------------



**SAFETY DATA SHEET**  
 according to Regulation (EC) No. 1907/2006  
 Valvoline™ OEM ADVANCED AFC 48 RTU  
 Coolant

Version: 5.0

Revision Date: 27.07.2023

Print Date: 17/07/2024

	EC-No. Index-No. Registration number		(% w/w)
ETHYLENE GLYCOL	107-21-1 203-473-3 603-027-00-1 01-2119456816-28- xxxx	Acute Tox. 4; H302 STOT RE 2; H373 (Kidney)	>= 40 - < 50
2-ETHYLHEXANOIC ACID	149-57-5 205-743-6 607-230-00-6	Repr. 2; H361d	>= 1 - < 2.5
SODIUM HYDROXIDE	1310-73-2 215-185-5 011-002-00-6 01-2119457892-27- xxxx	Met. Corr. 1; H290 Skin Corr. 1A; H314 Eye Dam. 1; H318  specific concentration limit Skin Corr. 1A; H314 >= 5 % Skin Corr. 1B; H314 2 - < 5 % Skin Irrit. 2; H315 0.5 - < 2 % Eye Irrit. 2; H319 0.5 - < 2 %	>= 0.5 - < 1
SODIUM BORATE DECAHYDRATE	1303-96-4 215-540-4 005-011-01-1	Eye Irrit. 2; H319 Repr. 1B; H360FD	>= 0.5 - < 1

For explanation of abbreviations see section 16.

**SECTION 4: First aid measures**

**4.1 Description of first aid measures**

General advice : Move out of dangerous area.  
 Show this safety data sheet to the doctor in attendance.  
 Do not leave the victim unattended.

If inhaled : If unconscious, place in recovery position and seek medical



**SAFETY DATA SHEET**  
according to Regulation (EC) No. 1907/2006  
Valvoline™ OEM ADVANCED AFC 48 RTU  
Coolant

Version: 5.0

Revision Date: 27.07.2023

Print Date: 17/07/2024

- advice.  
If symptoms persist, call a physician.
- In case of eye contact : Flush eyes with water as a precaution.  
Remove contact lenses.  
Protect unharmed eye.  
Keep eye wide open while rinsing.  
If eye irritation persists, consult a specialist.
- If swallowed : Keep respiratory tract clear.  
Do NOT induce vomiting.  
Do not give milk or alcoholic beverages.  
Never give anything by mouth to an unconscious person.  
If symptoms persist, call a physician.  
Take victim immediately to hospital.

**4.2 Most important symptoms and effects, both acute and delayed**

- Symptoms : No symptoms known or expected.
- Risks : Harmful if swallowed.  
May damage fertility. May damage the unborn child.  
May cause damage to organs through prolonged or repeated exposure if swallowed.

**4.3 Indication of any immediate medical attention and special treatment needed**

- Treatment : No hazards which require special first aid measures.  
  
Treat symptomatically.

---

**SECTION 5: Firefighting measures**

**5.1 Extinguishing media**

- Suitable extinguishing media : Use water spray, alcohol-resistant foam, dry chemical or carbon dioxide.
- Unsuitable extinguishing media : High volume water jet

**5.2 Special hazards arising from the substance or mixture**

- Specific hazards during firefighting : Do not allow run-off from fire fighting to enter drains or water courses.



**SAFETY DATA SHEET**  
according to Regulation (EC) No. 1907/2006  
Valvoline™ OEM ADVANCED AFC 48 RTU  
Coolant

Version: 5.0

Revision Date: 27.07.2023

Print Date: 17/07/2024

Hazardous combustion products : No hazardous combustion products are known

### 5.3 Advice for firefighters

Special protective equipment for firefighters : Wear self-contained breathing apparatus for firefighting if necessary.

Further information : Collect contaminated fire extinguishing water separately. This must not be discharged into drains.  
Fire residues and contaminated fire extinguishing water must be disposed of in accordance with local regulations.

---

## SECTION 6: Accidental release measures

### 6.1 Personal precautions, protective equipment and emergency procedures

Personal precautions : Use personal protective equipment.

### 6.2 Environmental precautions

Environmental precautions : Prevent product from entering drains.  
Prevent further leakage or spillage if safe to do so.  
If the product contaminates rivers and lakes or drains inform respective authorities.

### 6.3 Methods and material for containment and cleaning up

Methods for cleaning up : Soak up with inert absorbent material (e.g. sand, silica gel, acid binder, universal binder, sawdust).  
Keep in suitable, closed containers for disposal.

### 6.4 Reference to other sections

See sections: 7, 8, 11, 12 and 13.

---

## SECTION 7: Handling and storage

### 7.1 Precautions for safe handling

Advice on safe handling : Do not breathe vapours/dust.  
Avoid exposure - obtain special instructions before use.  
Avoid contact with skin and eyes.  
For personal protection see section 8.



**SAFETY DATA SHEET**  
 according to Regulation (EC) No. 1907/2006  
 Valvoline™ OEM ADVANCED AFC 48 RTU  
 Coolant

Version: 5.0

Revision Date: 27.07.2023

Print Date: 17/07/2024

- Smoking, eating and drinking should be prohibited in the application area.  
 Dispose of rinse water in accordance with local and national regulations.
- Advice on protection against fire and explosion : Normal measures for preventive fire protection.
- Hygiene measures : When using do not eat or drink. When using do not smoke. Wash hands before breaks and at the end of workday.

**7.2 Conditions for safe storage, including any incompatibilities**

- Requirements for storage areas and containers : Keep container tightly closed in a dry and well-ventilated place. Observe label precautions. Electrical installations / working materials must comply with the technological safety standards.
- Further information on storage stability : No decomposition if stored and applied as directed.

**7.3 Specific end use(s)**

- Specific use(s) : No data available

**SECTION 8: Exposure controls/personal protection**

**8.1 Control parameters**

**Occupational Exposure Limits**

Components	CAS-No.	Value type (Form of exposure)	Control parameters	Basis
ETHYLENE GLYCOL	107-21-1	TWA (Vapour)	20 ppm 52 mg/m3	GB EH40
		Further information: Can be absorbed through the skin. The assigned substances are those for which there are concerns that dermal absorption will lead to systemic toxicity.		
		TWA (particles)	10 mg/m3	GB EH40
		Further information: Can be absorbed through the skin. The assigned substances are those for which there are concerns that dermal absorption will lead to systemic toxicity.		
		STEL (Vapour)	40 ppm 104 mg/m3	GB EH40
		Further information: Can be absorbed through the skin. The assigned substances are those for which there are concerns that dermal absorption will lead to systemic toxicity.		
		TWA	20 ppm	2000/39/EC





**SAFETY DATA SHEET**  
 according to Regulation (EC) No. 1907/2006  
 Valvoline™ OEM ADVANCED AFC 48 RTU  
 Coolant

Version: 5.0

Revision Date: 27.07.2023

Print Date: 17/07/2024

			52 mg/m3	
	Further information: Identifies the possibility of significant uptake through the skin, Indicative			
		STEL	40 ppm 104 mg/m3	2000/39/EC
	Further information: Identifies the possibility of significant uptake through the skin, Indicative			
SODIUM HYDROXIDE	1310-73-2	STEL	2 mg/m3	GB EH40
SODIUM BORATE DECAHYDRATE	1303-96-4	TWA	5 mg/m3	GB EH40

**Derived No Effect Level (DNEL):**

Substance name	End Use	Exposure routes	Potential health effects	Value
SODIUM HYDROXIDE	Workers	Inhalation	LOCAL LT - Local, long-term	1 mg/m3
	Consumers	Inhalation	LOCAL LT - Local, long-term	1 mg/m3

**8.2 Exposure controls**

**Personal protective equipment**

Eye/face protection : Eye wash bottle with pure water  
Tightly fitting safety goggles

Hand protection

Remarks : The suitability for a specific workplace should be discussed with the producers of the protective gloves.

Skin and body protection : Impervious clothing  
Choose body protection according to the amount and concentration of the dangerous substance at the work place.

Respiratory protection : No personal respiratory protective equipment normally required.

**SECTION 9: Physical and chemical properties**

**9.1 Information on basic physical and chemical properties**

Appearance : liquid  
 Colour : blue  
 Odour : No data available  
 Odour Threshold : No data available

pH : ca. 9.25



**SAFETY DATA SHEET**  
according to Regulation (EC) No. 1907/2006  
Valvoline™ OEM ADVANCED AFC 48 RTU  
Coolant

Version: 5.0

Revision Date: 27.07.2023

Print Date: 17/07/2024

Melting point/freezing point	:	ca. -34 °C
Boiling point/boiling range	:	No data available
Flash point	:	Not applicable
Evaporation rate	:	No data available
Flammability (solid, gas)	:	No data available
Upper explosion limit / Upper flammability limit	:	No data available
Lower explosion limit / Lower flammability limit	:	No data available
Vapour pressure	:	No data available
Relative vapour density	:	No data available
Relative density	:	No data available
Density	:	ca. 1.075 g/cm <sup>3</sup> (15 °C)
Solubility(ies)		
Water solubility	:	No data available
Solubility in other solvents	:	No data available
Partition coefficient: n-octanol/water	:	No data available
Decomposition temperature	:	No data available
Viscosity		
Viscosity, dynamic	:	No data available
Viscosity, kinematic	:	Not applicable
Oxidizing properties	:	No data available

**9.2 Other information**

Self-ignition	:	No data available
---------------	---	-------------------



**SAFETY DATA SHEET**  
according to Regulation (EC) No. 1907/2006  
Valvoline™ OEM ADVANCED AFC 48 RTU  
Coolant

Version: 5.0

Revision Date: 27.07.2023

Print Date: 17/07/2024

---

## SECTION 10: Stability and reactivity

### 10.1 Reactivity

No decomposition if stored and applied as directed.

### 10.2 Chemical stability

No decomposition if stored and applied as directed.

### 10.3 Possibility of hazardous reactions

Hazardous reactions : No decomposition if stored and applied as directed.

### 10.4 Conditions to avoid

Conditions to avoid : excessive heat

### 10.5 Incompatible materials

Materials to avoid : Aldehydes  
Alkali metals  
Alkaline earth metals  
Amines  
Ammonia  
Bases  
chromium trioxide  
Copper  
Copper alloys  
Reducing agents  
Strong acids  
strong alkalis  
Strong oxidizing agents  
Sulphur compounds

### 10.6 Hazardous decomposition products

No hazardous decomposition products are known.

---

## SECTION 11: Toxicological information

### 11.1 Information on toxicological effects

#### Acute toxicity

Harmful if swallowed.

#### Product:

Acute oral toxicity : Acute toxicity estimate: 1,018 mg/kg



**SAFETY DATA SHEET**  
according to Regulation (EC) No. 1907/2006  
Valvoline™ OEM ADVANCED AFC 48 RTU  
Coolant

Version: 5.0

Revision Date: 27.07.2023

Print Date: 17/07/2024

Method: Calculation method

**Components:**

**ETHYLENE GLYCOL:**

Acute oral toxicity	:	<b>LD0 (Human): estimated 1.56 g/kg</b>  Assessment: <b>The component/mixture is moderately toxic after single ingestion.</b>
Acute inhalation toxicity	:	<b>LC50 (Rat): 10.9 mg/l</b> Exposure time: <b>1 h</b> Test atmosphere: <b>dust/mist</b> Assessment: <b>The substance or mixture has no acute inhalation toxicity</b>
Acute dermal toxicity	:	<b>LD50 (Rabbit): 9,530 mg/kg</b>
Acute toxicity (other routes of administration)	:	<b>LD50 (Rat): 5,010 mg/kg</b> Application Route: <b>Intraperitoneal</b>  <b>LD50 (Rat): 3,260 mg/kg</b> Application Route: <b>Intravenous</b>

**2-ETHYLHEXANOIC ACID:**

Acute oral toxicity	:	<b>LD50 (Rat, male): 3,000 mg/kg</b>  <b>LD50 (Rat, female): 2,043 mg/kg</b>
Acute inhalation toxicity	:	<b>LC0 (Rat): 0.11 mg/l</b> Exposure time: <b>8 h</b> Test atmosphere: <b>dust/mist</b> Method: <b>OECD Test Guideline 403</b> Assessment: <b>The substance or mixture has no acute inhalation toxicity</b>
Acute dermal toxicity	:	<b>LD50 (Rat): &gt; 2,000 mg/kg</b> Assessment: <b>The substance or mixture has no acute dermal toxicity</b> Remarks: <b>No mortality observed at this dose.</b>

**SODIUM HYDROXIDE:**

Acute oral toxicity	:	<b>LDLo (Rabbit): 500 mg/kg</b>
---------------------	---	---------------------------------



**SAFETY DATA SHEET**  
according to Regulation (EC) No. 1907/2006  
Valvoline™ OEM ADVANCED AFC 48 RTU  
Coolant

Version: 5.0

Revision Date: 27.07.2023

Print Date: 17/07/2024

Acute inhalation toxicity	: Assessment: <b>The substance or mixture has no acute inhalation toxicity</b> Remarks: <b>Moderate respiratory irritant</b>
Acute dermal toxicity	: Symptoms: <b>Corrosion</b> Assessment: <b>The substance or mixture has no acute dermal toxicity</b>

**SODIUM BORATE DECAHYDRATE:**

Acute oral toxicity	: <b>LD50 (Rat): &gt; 2,000 mg/kg</b> Assessment: <b>The substance or mixture has no acute oral toxicity</b> Remarks: <b>The toxicological data has been taken from products of similar composition. No mortality observed at this dose.</b>
Acute inhalation toxicity	: <b>LC50 (Rat): &gt; 2.04 mg/l</b> Exposure time: <b>4 h</b> Test atmosphere: <b>dust/mist</b> Method: <b>OECD Test Guideline 403</b> GLP: <b>yes</b> Assessment: <b>The substance or mixture has no acute inhalation toxicity</b> Remarks: <b>The toxicological data has been taken from products of similar composition. No mortality observed at this dose.</b>
Acute dermal toxicity	: <b>LD50 (Rabbit): &gt; 2,000 mg/kg</b> GLP: <b>yes</b> Assessment: <b>The substance or mixture has no acute dermal toxicity</b> Remarks: <b>The toxicological data has been taken from products of similar composition. No mortality observed at this dose.</b>

**Skin corrosion/irritation**

Not classified based on available information.

**Product:**

Result : No skin irritation

**Components:**

**ETHYLENE GLYCOL:**

Species	: <b>Rabbit</b>
---------	-----------------



**SAFETY DATA SHEET**  
according to Regulation (EC) No. 1907/2006  
Valvoline™ OEM ADVANCED AFC 48 RTU  
Coolant

Version: 5.0

Revision Date: 27.07.2023

Print Date: 17/07/2024

Result : No skin irritation

**2-ETHYLHEXANOIC ACID:**

Species : Rabbit  
Result : Slight, transient irritation

**SODIUM HYDROXIDE:**

Result : Corrosive after 3 minutes or less of exposure

**SODIUM BORATE DECAHYDRATE:**

Species : Rabbit  
Result : Slight, transient irritation

**Serious eye damage/eye irritation**

Not classified based on available information.

**Product:**

Result : No eye irritation

**Components:**

**ETHYLENE GLYCOL:**

Result : Slight, transient irritation

**2-ETHYLHEXANOIC ACID:**

Species : Rabbit  
Result : Slight, transient irritation

**SODIUM HYDROXIDE:**

Assessment : Corrosive  
Result : Corrosive

**SODIUM BORATE DECAHYDRATE:**

Species : Rabbit  
Result : Irritating to eyes.



**SAFETY DATA SHEET**  
according to Regulation (EC) No. 1907/2006  
Valvoline™ OEM ADVANCED AFC 48 RTU  
Coolant

Version: 5.0

Revision Date: 27.07.2023

Print Date: 17/07/2024

**Respiratory or skin sensitisation**

**Skin sensitisation**

Not classified based on available information.

**Respiratory sensitisation**

Not classified based on available information.

**Components:**

**ETHYLENE GLYCOL:**

Test Type	:	Maximisation Test
Species	:	Guinea pig
Assessment	:	Does not cause skin sensitisation.

**2-ETHYLHEXANOIC ACID:**

Test Type	:	Maximisation Test
Species	:	Guinea pig
Assessment	:	Does not cause skin sensitisation.
Method	:	OECD Test Guideline 406

**SODIUM HYDROXIDE:**

Exposure routes	:	Skin contact
Species	:	Humans
Result	:	negative

**SODIUM BORATE DECAHYDRATE:**

Test Type	:	Buehler Test
Species	:	Guinea pig
Assessment	:	Does not cause skin sensitisation.
Remarks	:	The toxicological data has been taken from products of similar composition.

**Germ cell mutagenicity**

Not classified based on available information.

**Components:**

**ETHYLENE GLYCOL:**

Genotoxicity in vitro	:	Test Type: Ames test Test system: Salmonella typhimurium Metabolic activation: with and without metabolic activation
-----------------------	---	--



**SAFETY DATA SHEET**  
according to Regulation (EC) No. 1907/2006  
Valvoline™ OEM ADVANCED AFC 48 RTU  
Coolant

Version: 5.0

Revision Date: 27.07.2023

Print Date: 17/07/2024

Result: **negative**

**2-ETHYLHEXANOIC ACID:**

Genotoxicity in vitro : Test Type: **Ames test**  
Test system: **Salmonella typhimurium**  
Metabolic activation: **with and without metabolic activation**  
Result: **negative**

**Carcinogenicity**

Not classified based on available information.

**Reproductive toxicity**

May damage fertility. May damage the unborn child.

**Components:**

**2-ETHYLHEXANOIC ACID:**

Reproductive toxicity - Assessment : **Some evidence of adverse effects on development, based on animal experiments.**

**SODIUM BORATE DECAHYDRATE:**

Reproductive toxicity - Assessment : **Clear evidence of adverse effects on sexual function and fertility, and/or on development, based on animal experiments**

**STOT - single exposure**

Not classified based on available information.

**STOT - repeated exposure**

May cause damage to organs (Kidney) through prolonged or repeated exposure if swallowed.

**Components:**

**ETHYLENE GLYCOL:**

Exposure routes : **Ingestion**  
Target Organs : **Kidney**  
Assessment : **May cause damage to organs through prolonged or repeated exposure.**

**Aspiration toxicity**

Not classified based on available information.





**SAFETY DATA SHEET**  
according to Regulation (EC) No. 1907/2006  
Valvoline™ OEM ADVANCED AFC 48 RTU  
Coolant

Version: 5.0

Revision Date: 27.07.2023

Print Date: 17/07/2024

**Experience with human exposure**

**Components:**

**ETHYLENE GLYCOL:**

Ingestion : Target Organs: **Kidney**

**Further information**

**Product:**

Remarks : No data available

**SECTION 12: Ecological information**

**12.1 Toxicity**

**Product:**

**Ecotoxicology Assessment**

Acute aquatic toxicity : Not classified based on available information.

Chronic aquatic toxicity : Not classified based on available information.

**Components:**

**ETHYLENE GLYCOL:**

Toxicity to fish : **LC50 (Lepomis macrochirus (Bluegill sunfish)): 27,540 mg/l**  
Exposure time: **96 h**  
Test Type: **static test**

**LC50 (Pimephales promelas (fathead minnow)): 8,050 mg/l**  
Exposure time: **96 h**

Toxicity to daphnia and other aquatic invertebrates : **LC50 (Daphnia magna (Water flea)): > 10,000 mg/l**  
Exposure time: **48 h**  
Test Type: **static test**

Toxicity to algae/aquatic plants : **EC50 (Pseudokirchneriella subcapitata (green algae)): 6,500 - 13,000 mg/l**  
End point: **Growth inhibition**  
Exposure time: **7 Days**



**SAFETY DATA SHEET**  
according to Regulation (EC) No. 1907/2006  
Valvoline™ OEM ADVANCED AFC 48 RTU  
Coolant

Version: 5.0

Revision Date: 27.07.2023

Print Date: 17/07/2024

Toxicity to fish (Chronic toxicity)	: NOEC: 32,000 mg/l Exposure time: 7 d Species: Pimephales promelas (fathead minnow)
Toxicity to daphnia and other aquatic invertebrates (Chronic toxicity)	: NOEC: 24,000 mg/l Exposure time: 7 d Species: Daphnia magna (Water flea)

**Ecotoxicology Assessment**

Acute aquatic toxicity	: Not classified based on available information.
Chronic aquatic toxicity	: Not classified based on available information.

**2-ETHYLHEXANOIC ACID:**

Toxicity to fish	: LC50 (Oncorhynchus mykiss (rainbow trout)): > 100 mg/l Exposure time: 96 h Test Type: static test
Toxicity to daphnia and other aquatic invertebrates	: EC50 (Daphnia magna (Water flea)): 85.4 mg/l Exposure time: 48 h Test Type: static test
Toxicity to algae/aquatic plants	: EC50 (Desmodesmus subspicatus (green algae)): 49.3 mg/l End point: Growth inhibition Exposure time: 72 h Test Type: static test

**Ecotoxicology Assessment**

Acute aquatic toxicity	: Harmful to aquatic life.
Chronic aquatic toxicity	: Not classified based on available information.

**SODIUM HYDROXIDE:**

Toxicity to fish	: LC50 (Gambusia affinis (Mosquito fish)): 125 mg/l Exposure time: 96 h Method: Static Remarks: Mortality
Toxicity to daphnia and other aquatic invertebrates	: EC50 (Daphnia magna (Water flea)): 34.59 - 47.13 mg/l Exposure time: 48 h Remarks: Intoxication
Toxicity to microorganisms	:



**SAFETY DATA SHEET**  
according to Regulation (EC) No. 1907/2006  
Valvoline™ OEM ADVANCED AFC 48 RTU  
Coolant

Version: 5.0

Revision Date: 27.07.2023

Print Date: 17/07/2024

Remarks: **Not applicable**

**Ecotoxicology Assessment**

Acute aquatic toxicity : **Neutralisation will reduce ecotoxic effects.**  
**Not classified based on available information.**

Chronic aquatic toxicity : **This product has no known ecotoxicological effects.**  
**Not classified based on available information.**

**SODIUM BORATE DECAHYDRATE:**

Toxicity to fish : **LC50 (Fish): > 100 mg/l**  
Exposure time: **96 h**  
Remarks: **The toxicological data has been taken from products of similar composition.**

Toxicity to daphnia and other aquatic invertebrates : **LC50 (Daphnia magna (Water flea)): 133 mg/l**  
Exposure time: **48 h**  
Test Type: **static test**  
Remarks: **The toxicological data has been taken from products of similar composition.**

Toxicity to algae/aquatic plants : **NOEC (Dunaliella tertiolecta (marine algae)): 50 mg/l**  
End point: **Growth inhibition**  
Exposure time: **240 h**  
Test Type: **static test**  
Remarks: **Information refers to the main component.**

Toxicity to fish (Chronic toxicity) : **NOEC: 13 mg/l**  
Exposure time: **4 d**  
Species: **Danio rerio (zebra fish)**  
Remarks: **Information refers to the main component.**

Toxicity to daphnia and other aquatic invertebrates (Chronic toxicity) : **NOEC: 16.6 mg/l**  
Exposure time: **28 d**  
Species: **Aquatic invertebrates**  
Test Type: **flow-through test**  
Remarks: **Information refers to the main component.**

**Ecotoxicology Assessment**

Acute aquatic toxicity : **Not classified based on available information.**

Chronic aquatic toxicity : **Not classified based on available information.**



**SAFETY DATA SHEET**  
according to Regulation (EC) No. 1907/2006  
Valvoline™ OEM ADVANCED AFC 48 RTU  
Coolant

Version: 5.0

Revision Date: 27.07.2023

Print Date: 17/07/2024

## 12.2 Persistence and degradability

### Components:

#### ETHYLENE GLYCOL:

Biodegradability : Result: **Readily biodegradable.**  
Biodegradation: **90 - 100 %**  
Exposure time: **10 d**  
Method: **OECD Test Guideline 301**

#### 2-ETHYLHEXANOIC ACID:

Biodegradability : Result: **Readily biodegradable.**  
Biodegradation: **99 %**  
Exposure time: **28 d**

## 12.3 Bioaccumulative potential

### Components:

#### ETHYLENE GLYCOL:

Bioaccumulation : Species: **Crayfish (Procambarus)**  
Exposure time: **61 d**  
Concentration: **1000 mg/l**  
Bioconcentration factor (BCF): **0.27**  
Method: **Flow through**

Partition coefficient: n-octanol/water : log Pow: **-1.36**

#### 2-ETHYLHEXANOIC ACID:

Partition coefficient: n-octanol/water : log Pow: **2.64**

## 12.4 Mobility in soil

No data available

## 12.5 Results of PBT and vPvB assessment

### Product:

Assessment : This substance/mixture contains no components considered to be either persistent, bioaccumulative and toxic (PBT), or very persistent and very bioaccumulative (vPvB) at levels of 0.1% or higher.



**SAFETY DATA SHEET**  
according to Regulation (EC) No. 1907/2006  
Valvoline™ OEM ADVANCED AFC 48 RTU  
Coolant

Version: 5.0

Revision Date: 27.07.2023

Print Date: 17/07/2024

---

**12.6 Other adverse effects**

**Product:**

- Endocrine disrupting potential : The substance/mixture does not contain components considered to have endocrine disrupting properties according to REACH Article 57(f) or Commission Delegated regulation (EU) 2017/2100 or Commission Regulation (EU) 2018/605 at levels of 0.1% or higher.
- Additional ecological information : No data available

---

**SECTION 13: Disposal considerations**

**13.1 Waste treatment methods**

- Product : Do not dispose of waste into sewer.  
Do not contaminate ponds, waterways or ditches with chemical or used container.  
Send to a licensed waste management company.
- Contaminated packaging : Empty remaining contents.  
Dispose of as unused product.  
Do not re-use empty containers.

---

**SECTION 14: Transport information**

**14.1 UN number**

- ADR : Not regulated as a dangerous good  
RID : Not regulated as a dangerous good  
IMDG : Not regulated as a dangerous good  
IATA\_P : Not regulated as a dangerous good

**14.2 UN proper shipping name**

- ADR : Not regulated as a dangerous good  
RID : Not regulated as a dangerous good  
IMDG : Not regulated as a dangerous good  
IATA\_P : Not regulated as a dangerous good

**14.3 Transport hazard class(es)**



**SAFETY DATA SHEET**  
according to Regulation (EC) No. 1907/2006  
Valvoline™ OEM ADVANCED AFC 48 RTU  
Coolant

Version: 5.0

Revision Date: 27.07.2023

Print Date: 17/07/2024

**ADR** : Not regulated as a dangerous good  
**RID** : Not regulated as a dangerous good  
**IMDG** : Not regulated as a dangerous good  
**IATA\_P** : Not regulated as a dangerous good

**14.4 Packing group**

**ADR** : Not regulated as a dangerous good  
**RID** : Not regulated as a dangerous good  
**IMDG** : Not regulated as a dangerous good  
**IATA (Cargo)** : Not regulated as a dangerous good  
**IATA\_P (Passenger)** : Not regulated as a dangerous good

**14.5 Environmental hazards**

Not regulated as a dangerous good

**14.6 Special precautions for user**

Not applicable

**14.7 Transport in bulk according to Annex II of Marpol and the IBC Code**

Not applicable for product as supplied.

Dangerous goods descriptions (if indicated above) may not reflect quantity, end-use or region-specific exceptions that can be applied. Consult shipping documents for descriptions that are specific to the shipment.

**SECTION 15: Regulatory information**

**15.1 Safety, health and environmental regulations/legislation specific for the substance or mixture**

Relevant EU provisions transposed through retained EU law

UK REACH List of restrictions (Annex 17) : Conditions of restriction for the following entries should be considered:  
Number on list 3  
UK REACH Candidate list of substances of very high concern (SVHC) for Authorisation : SODIUM BORATE DECAHYDRATE  
The Persistent Organic Pollutants Regulations (retained Regulation (EU) 2019/1021 as amended for Great Britain) : Not applicable  
Regulation (EC) No 1005/2009 on substances that deplete the ozone layer : Not applicable  
UK REACH List of substances subject to authorisation : Not applicable



**SAFETY DATA SHEET**  
according to Regulation (EC) No. 1907/2006  
Valvoline™ OEM ADVANCED AFC 48 RTU  
Coolant

Version: 5.0

Revision Date: 27.07.2023

Print Date: 17/07/2024

(Annex XIV)  
Control of Major Accident Hazards Regulations  
2015 (COMAH) Not applicable

**Other regulations:**

Take note of The Management of Health and Safety at Work Regulations 1999 (requirements relating to new and expectant mothers at work contained in Regulation 16 to 18) and of the Pregnant Workers Directive 92/85/EEC.

Take note of The Management of Health and Safety at Work Regulations 1999 (requirements relating to protection of young people at work contained in Regulation 19) and of Directive 94/33/EC on the protection of young people at work.

**The components of this product are reported in the following inventories:**

- TCSI : On the inventory, or in compliance with the inventory
- TSCA : All substances listed as active on the TSCA inventory
- AIIC : On the inventory, or in compliance with the inventory
- DSL : All components of this product are on the Canadian DSL
  
- ENCS : On the inventory, or in compliance with the inventory
- KECI : On the inventory, or in compliance with the inventory
- PICCS : On the inventory, or in compliance with the inventory
- IECSC : On the inventory, or in compliance with the inventory
- NZIoC : Not in compliance with the inventory

**15.2 Chemical safety assessment**

No data available

**Inventories**

AIIC (Australia), DSL (Canada), IECSC (China), REACH (European Union), ENCS (Japan), ISHL (Japan), KECI (Korea), NZIoC (New Zealand), PICCS (Philippines), TCSI (Taiwan), TECI (Thailand), TSCA (USA)

---

**SECTION 16: Other information**

**Full text of H-Statements**

- H290 : May be corrosive to metals.
- H302 : Harmful if swallowed.



## SAFETY DATA SHEET

according to Regulation (EC) No. 1907/2006  
Valvoline™ OEM ADVANCED AFC 48 RTU  
Coolant

Version: 5.0

Revision Date: 27.07.2023

Print Date: 17/07/2024

H314	:	Causes severe skin burns and eye damage.
H318	:	Causes serious eye damage.
H319	:	Causes serious eye irritation.
H360FD	:	May damage fertility. May damage the unborn child.
H361d	:	Suspected of damaging the unborn child.
H373	:	May cause damage to organs through prolonged or repeated exposure if swallowed.

### Full text of other abbreviations

Acute Tox.	:	Acute toxicity
Eye Dam.	:	Serious eye damage
Eye Irrit.	:	Eye irritation
Met. Corr.	:	Corrosive to metals
Repr.	:	Reproductive toxicity
Skin Corr.	:	Skin corrosion
STOT RE	:	Specific target organ toxicity - repeated exposure
2000/39/EC	:	Europe. Commission Directive 2000/39/EC establishing a first list of indicative occupational exposure limit values
GB EH40	:	UK. EH40 WEL - Workplace Exposure Limits
2000/39/EC / TWA	:	Limit Value - eight hours
2000/39/EC / STEL	:	Short term exposure limit
GB EH40 / TWA	:	Long-term exposure limit (8-hour TWA reference period)
GB EH40 / STEL	:	Short-term exposure limit (15-minute reference period)

ADN - European Agreement concerning the International Carriage of Dangerous Goods by Inland Waterways; ADR - Agreement concerning the International Carriage of Dangerous Goods by Road; AIIIC - Australian Inventory of Industrial Chemicals; ASTM - American Society for the Testing of Materials; bw - Body weight; CLP - Classification Labelling Packaging Regulation; Regulation (EC) No 1272/2008; CMR - Carcinogen, Mutagen or Reproductive Toxicant; DIN - Standard of the German Institute for Standardisation; DSL - Domestic Substances List (Canada); ECHA - European Chemicals Agency; EC-Number - European Community number; ECx - Concentration associated with x% response; ELx - Loading rate associated with x% response; EmS - Emergency Schedule; ENCS - Existing and New Chemical Substances (Japan); ErCx - Concentration associated with x% growth rate response; GHS - Globally Harmonized System; GLP - Good Laboratory Practice; IARC - International Agency for Research on Cancer; IATA - International Air Transport Association; IBC - International Code for the Construction and Equipment of Ships carrying Dangerous Chemicals in Bulk; IC50 - Half maximal inhibitory concentration; ICAO - International Civil Aviation Organization; IECSC - Inventory of Existing Chemical Substances in China; IMDG - International Maritime Dangerous Goods; IMO - International Maritime Organization; ISHL - Industrial Safety and Health Law (Japan); ISO - International Organisation for Standardization; KECI - Korea Existing Chemicals Inventory; LC50 - Lethal Concentration to 50 % of a test population; LD50 - Lethal Dose to 50% of a test population (Median Lethal Dose); MARPOL - International Convention for the Prevention of Pollution from Ships; n.o.s. - Not Otherwise Specified; NO(A)EC - No Observed (Adverse) Effect Concentration; NO(A)EL - No Observed (Adverse) Effect Level; NOELR - No Observable Effect Loading Rate; NZIoC - New Zealand Inventory of Chemicals; OECD - Organization for Economic Co-operation and Development; OPPTS - Office of Chemical Safety and Pollution Prevention; PBT - Persistent, Bioaccumulative and Toxic substance; PICCS - Philippines Inventory of Chemicals and





**SAFETY DATA SHEET**  
according to Regulation (EC) No. 1907/2006  
Valvoline™ OEM ADVANCED AFC 48 RTU  
Coolant

Version: 5.0

Revision Date: 27.07.2023

Print Date: 17/07/2024

Chemical Substances; (Q)SAR - (Quantitative) Structure Activity Relationship; REACH - Regulation (EC) No 1907/2006 of the European Parliament and of the Council concerning the Registration, Evaluation, Authorisation and Restriction of Chemicals; RID - Regulations concerning the International Carriage of Dangerous Goods by Rail; SADT - Self-Accelerating Decomposition Temperature; SDS - Safety Data Sheet; SVHC - Substance of very high concern; TCSI - Taiwan Chemical Substance Inventory; TECI - Thailand Existing Chemicals Inventory; TSCA - Toxic Substances Control Act (United States); UN - United Nations; UNRTDG - United Nations Recommendations on the Transport of Dangerous Goods; vPvB - Very Persistent and Very Bioaccumulative

**Further information**

Internal information : 000000276878

**Classification of the mixture:**

Acute Tox. 4                      H302  
STOT RE 2                        H373

**Classification procedure:**

Calculation method  
Calculation method

The information provided in this Safety Data Sheet is correct to the best of our knowledge, information and belief at the date of its publication. The information given is designed only as a guidance for safe handling, use, processing, storage, transportation, disposal and release and is not to be considered a warranty or quality specification. The information relates only to the specific material designated and may not be valid for such material used in combination with any other materials or in any process, unless specified in the text.

GB / EN



# Instructions for the safe handling of lead-acid accumulators (Lead-acid batteries)

## 1. Identification of the article and the company

Data on the product: Trade name

Lead-acid battery filled with diluted sulphuric acid

**Clarios Germany GmbH & Co. KGaA**  
Am Leineufer 51  
D-30419 Hanover

Contact: Dr. Axel Lesch, Director, Environment & Facility Management

Telephone: ++ 49 / 511/975-2690  
Fax: ++ 49 / 511/975-2696  
Emergency: ++ 49 / 511/975-2680  
Email: [Axel.Lesch@clarios.com](mailto:Axel.Lesch@clarios.com)

## 2. Hazard identification:

No hazards in case of an intact battery and observation of the instructions for use.

Lead acid batteries have two significant characteristics:

- They contain diluted sulphuric acid, which may cause severe acid burns, when the material is touched.
- During the charging process they develop hydrogen gas and oxygen, which under certain circumstances may turn into an explosive mixture.

For this reason, batteries are marked with the following hazard symbols <sup>1)</sup>

		No smoking, no naked flames, no sparks
		Shield eyes
		Corrosive (Battery acid)
		Note operating instructions
		Explosive gas
		Keep away from children's reach

<sup>1)</sup> The hazard symbols on the left side correspond to ISO 7010. The hazard symbols on the right side correspond to the European industry standard EN 50342-1 for starter batteries. In dependence of the respective normative background the hazard symbols shown here are suitable to fulfil the safety-related requirements. A marking of batteries after GHS CLP-regulation is not required.

Note: Do not clean batteries with dry wishers, use only wet wishers, due to electrostatic charge

### 3. Composition / Information on Ingredients:

EINECS-No.	CAS-No.	Reach Register No.	Description	Content [% of weight] <sup>1</sup>	Classification 1272/2008 (CLP)
231-100-4	7439-92-1	01-2119513221-59-0069	Lead and lead alloys	~ 32	GHS 08, Signal word: Danger Repr. 1 A, H 360 FD Lact. H 362 STOT RE 1, H 372 Lead metal is a substances of the Reach Candidate List
231-100-4	7439-92-1	01-2119513221-59-0069	Active mass (battery lead paste)	~ 32	GHS 07, Acute Tox. 4, H 302, H 332 GHS 08, Signal word: Danger Repr. 1 A, H 360 FD, Lact. H 362 STOT RE 1, H 372 Aquatic Chronic 3, H 412
231-639-5	7664-93-9	01-2119458838-20-0122	Diluted sulphuric acid <sup>2</sup>	~ 29	GHS 05, Signal word: Danger H 314
-	-	-	Plastic container <sup>3</sup>	~ 7	-

<sup>1</sup> Content may vary

<sup>2</sup> Concentration of diluted sulphuric acid varies in accordance to the state of charge.

<sup>3</sup> Composition of the plastic may vary due to different customer requirements.

### 4. First aid measures:

The information below is of relevance only, if the battery is damaged and direct contact to the contained compounds takes places.

According EC 1272/2008 (CLP) the contained compounds are classified as hazardous.

#### 4.1 Diluted sulphuric acid:

Hazard Statement according EC 1272/2008 (CLP):

H314 Causes severe skin burns and eye damages

Precautionary Statements according EC 1272/2008 (CLP):

P264 Wash hands thoroughly after handling.  
P301+P330+P331 If swallowed: rinse mouth. Do not induce vomiting.  
P280 Wear protective gloves/protective clothing/eye protection.  
P260 Do not breathe dust/fume/gas/mist/vapors/spray.  
P363 Wash contaminated clothing before reuse.  
P303+P361+P353 If on skin (or hair): Remove/Take off immediately all contaminated clothing. Rinse skin with water/shower.

In case of exposure: Seek advice of medical doctor.

## 4.2 **Battery lead paste:**

Hazard Statements according EC 1272/2008 (CLP):

H302	Harmful if swallowed.
H332	Harmful if inhaled.
H360 FD	May damage the unborn child. Suspected of damaging fertility.
H362	May cause harm to breast-fed children
H372	Causes damage to organs (the central nervous system and system for reproduction) through prolonged or repeated exposure.
H412	Harmful to aquatic life with long lasting effects.

Precautionary Statements according EC 1272/2008 (CLP):

P101	If medical advice is needed, have product container or label at hand.
P202	Do not handle until all safety precautions have been read and understood.
P263	Avoid contact during pregnancy/while nursing.
P273	Avoid release to the environment.
P308+P313	If exposed or concerned: Get medical advice/attention.
P405	Store locked up.
P501	Dispose of contents/container according to the local waste management regulations.

## 5. **Fire-fighting measures:**

- Suitable extinguishing agents:  
Water and foam are suitable extinguishing agents. For incipient fire CO<sub>2</sub> is most efficient agent
- Special protective equipment:  
Protective goggles, respiratory protective equipment, acid proof clothing
- Hazards which can be caused by a fire.  
Hazardous combustion gases can be generated. Lead vapor, Lead oxides, Sulphur dioxide :

## 6. **Accidental release measures:**

- Cleaning / take-up procedures:  
  
Use a bonding agent, such as sand, use lime or sodium carbonate for neutralization; dispose with due regard to the official local regulations. Do not permit penetration into the sewage system, the earth or water bodies.

## 7. **Handling and storage:**

Store under roof in cool ambience-charged lead-acid batteries do not freeze up to -50°C; prevent short circuits. Seek agreement with local water authorities in case of larger quantities. If batteries have to be charged in storage rooms, it is imperative that the instructions for use are observed. Additional Information about the storage of lead-acid batteries can be requested from Clarios Germany GmbH Co. KGaA.

## 8. **Exposure controls / personal protection:**

- 8.1 No exposure caused by lead, lead containing battery paste and sulphuric acid when handling properly.

8.2 In case of a damaged battery and with direct contact to the contained sulphuric acid.

Dermal: Sulphuric acid is corrosive. DNEL values for local dermal effects are not derived.

Inhalation: 0,1 mg/m<sup>3</sup>

Personal protective equipment (in case of a damaged battery):

Eye protection: Safety glasses (are necessary during recharging also)

Recommend safety gloves for contact with sulphuric acid. :

Type of material: Rubber, PVC gloves acid proof  
Acid proof clothing, safety boots.

9. **Physical and chemical properties:**

Diluted sulphuric acid (30 to 38.5 %)	Lead
<b>Appearance</b>	<b>Appearance</b>
form: liquid	form: solid
colour: colourless	colour: grey
odour: odourless	odour: odourless
<b>Safety-related data</b>	<b>Safety-related data</b>
pH-value(25°C): 0,3 (49 mg/l water)	pH-value(25°C): 7 – 8 (100 mg/l water)
solidification point: -35 to -60 °C	solidification point: 327 °C
boiling point: approx. 108 to 144°C	boiling point: 1.740 °C
solubility in water: Sulphuric acid is (25°C) miscible with water	solubility in water: low (0.15 mg/l)(25 °C)
density (20 °C): (1.2 to 1.3) g/cm <sup>3</sup>	density (20 °C): 11.35 g/cm <sup>3</sup>
vapour pressure (20 °C) 14.6 mbar	vapour pressure (20 °C) -
flash point: non combustible	flash point: non combustible
explosive properties: non explosive	explosive properties: non explosive

10. **Stability and reactivity:**

**Diluted sulphuric acid:**

10.1 **Reactivity**

Attacks many metals producing extremely flammable hydrogen gas which can form explosive mixtures with air. Destroys organic materials, such as cardboard, wood, textiles.

10.2 **Chemical stability**

Thermal decomposition at 338 °C

10.3 **Possibility of hazardous reactions**

Reaction with many metals produced extremely flammable hydrogen gas which can form explosive mixtures with air.

10.4 **Incompatible materials**

Vigorous reactions with alkalis.

10.5 **Hazardous decomposition products**

Under normal conditions of storage and use, hazardous decomposition products should not be produced.

## 11. Toxicological information:

### 11.1 Diluted Sulphuric acid:

#### 11.1.1 Information on toxicological effects:

Sulphuric acid immediately dissociates to the hydrogen and sulphate ions, with the hydrogen ion being responsible for the local toxicity (irritation and corrosively) of sulphuric acid.

#### 11.1.2 Acute toxicity:

Oral, rat, LD50: 2140 mg/kg bw (similar to OECD 401)  
Inhalation, rat LC50 : 375 mg/m<sup>3</sup> air (OECD Guideline 403)

Dermal: No data on acute dermal toxicity in animals are available. Although this is a potential route of exposure for workers, testing is not justified for scientific reasons and on animal welfare grounds. The effects of acute dermal exposure to sulphuric acid on animals can be readily predicted, and the data from human exposure are sufficient to characterize the effects.

No classification for acute toxicity is proposed according to current EU criteria.

#### 11.1.3 Irritation and corrosion:

Skin irritation / corrosion: corrosive

Eye irritation: corrosive

Sulphuric acid is listed on Annex I of Directive 1272/2008 (CLP) with classification

Skin Corrosive 1 A > 15 %.

No studies of dermal irritation / corrosion have been performed with the substance and none are proposed, based on scientific considerations and for reasons of animal welfare.

#### 11.1.4 Sensitization:

No classification is proposed for skin sensitization or respiratory sensitization based on theoretical considerations and in the absence of any findings in exposed humans following occupational use over a long period of time.

#### 11.1.5 Subacute, subchronic and prolonged toxicity (Repeated dose toxicity)

Inhalation (subacute, inhalation: aerosol, nose only), rat NOAEC: 0.3 mg/m<sup>3</sup> air (OECD Guideline 412).

Target organs: respiratory: larynx

Classification for severe effects after repeated or prolonged exposure is not proposed.

#### 11.1.6 Mutagenicity:

Genetic toxicity: negative. No classification is proposed for genotoxicity

#### 11.1.7 Carcinogenicity:

The available animal data do not support the classification of sulphuric acid for carcinogenicity.

#### 11.1.8 Reproductive toxicity:

Inhalation, rabbit, mouse: NOAEC: 19.3 mg/m<sup>3</sup> air (OECD Guideline 414).

No classification is proposed for reproductive or developmental toxicity

#### 11.1.9 **STOT-single exposure:**

Sulfuric acid is not classified for STOT SE.

#### 11.1.10 **STOT-repeated exposure:**

Sulfuric acid is not classified for STOT RE.

#### 11.1.11 **Aspiration hazard:**

Sulfuric acid is not classified for aspiration hazard.

#### 11.1.12 **Other information on acute toxicity:**

No other information available.

### 11.2 **Battery lead paste:**

#### 11.2.1 **Information on toxicological effects:**

The toxicity of this product has not been tested. The assessment of the toxicity has been done using the test data with similar inorganic lead compounds.

#### 11.2.2 **Toxicokinetic assessment:**

Inorganic lead compounds are slowly absorbed by ingestion and inhalation and poorly absorbed through the skin. If absorbed, lead will accumulate in the body with low rates of excretion, leading to long-term build up. Part of risk management is to take blood samples from workers for analysis to ensure that exposure levels are acceptable.

#### 11.2.3 **Acute toxicity:**

Sparingly soluble inorganic lead compounds have generally been found to be of relatively low acute toxicity by ingestion, in contact with skin, and by inhalation. Nevertheless current EU regulations require this substance to be classified as harmful by ingestion and inhalation.

#### 11.2.4 **Toxicity data:**

LD50 (oral, rat) > 2000 mg/kg  
LD50 (dermal, rat) > 2000 mg/kg  
LC50 (4 hr inhalation, rat) > 5 mg/L

No toxicity data available for Lead metal (lead metal powder, particle < 1mm).

#### 11.2.5 **Irritation and corrosion:**

Skin: Studies of similar sparingly soluble inorganic lead compounds have shown that they are not corrosive or irritating to the skin of rabbits. This is supported by the lack of reports of irritant effects from occupational settings.

Eyes: Studies of lead monoxide and similar sparingly soluble inorganic lead compounds have shown that they are not corrosive or irritating to the eyes of rabbits.

Respiratory: No symptoms of respiratory irritation were noted during long-term inhalation studies involving lead monoxide.

#### 11.2.6 **Sensitization:**

There is no evidence that sparingly soluble inorganic lead compounds cause respiratory or skin Sensitization.



#### 11.2.7 **Subacute, subchronic and prolonged toxicity:**

#### 11.2.8 **Germ cell mutagenicity:**

The evidence for genotoxic effects of highly soluble inorganic lead compounds is contradictory, with numerous studies reporting both positive and negative effects. Responses appear to be induced by indirect mechanisms, mostly at very high concentrations that lack physiological relevance.

#### 11.2.9 **Carcinogenicity:**

There is evidence that highly soluble inorganic lead compounds may have a carcinogenic effect, particularly on the kidneys of rats. However, the mechanisms by which this effect occurs are still unclear. Epidemiology studies of workers exposed to inorganic lead compounds have found a limited association with stomach cancer. This has led to the classification by IARC that inorganic lead compounds are probably carcinogenic to humans (Group 2A).

#### 11.2.10 **Reproductive toxicity:**

Exposure to high levels of inorganic lead compounds may cause adverse effects on male and female fertility, including adverse effects on sperm quality. Prenatal exposure to inorganic lead compounds is also associated with adverse effects on neurobehavioral development in children.

#### 11.2.11 **STOT-single exposure:**

Sparingly soluble inorganic lead compounds have generally been found to be of relatively low acute toxicity by ingestion, in contact with skin, and by inhalation, with no evidence of any local or systemic toxicity from such exposures, reproductive function and the central nervous system.

#### 11.2.12 **STOT-repeated exposure:**

Inorganic lead compounds are cumulative poisons and may be absorbed into the body through ingestion or inhalation. Inorganic lead compounds have been documented in observational human studies to produce toxicity in multiple organ systems and body function including the haematopoietic (blood) system, kidney function.

#### 11.2.13 **Aspiration hazard:**

Inorganic lead compounds is not classified for aspiration hazard.

#### 11.2.14 **Other information on acute toxicity:**

No other information available.

### 12. **Ecological information:**

#### 12.1 **Diluted sulphuric acid:**

##### 12.1.1 **Toxicity:**

##### **Aquatic toxicity:**

This substance is not classified as hazardous to the aquatic environment. Results on aquatic toxicity in freshwater:

##### **Short-term toxicity:**

Fish, *Lepomis macrochirus*, LC50 (96 h): > 16-< 28 mg/L. (no information on test methodology)

### 12.1.2 **Bioaccumulative potential:**

Sulphuric acid is a strong mineral acid (pKa =1.92) that dissociates readily in water to hydrogen ions and sulphate ions (at environmentally relevant pH) and is totally miscible with water. The resulting hydrogen ions and sulphate ions are naturally present in water/sediment and no bioaccumulation of these ions is predicted.

### 12.1.3 **Mobility in soil:**

Sulphuric acid is a strong mineral acid that dissociates readily in water to hydrogen ions and sulphate ions (at environmentally relevant pH) and is totally miscible with water. The resulting hydrogen ions and sulphate ions are naturally present in water/sediment. The hydrogen ions will contribute to local pH and are potentially mobile; sulphate ions may be incorporated into naturally occurring mineral species.

### 12.1.4 **Results of PBT and vPvB assessment:**

Sulphuric acid is neither a PBT nor a vPvB substance.

### 12.1.5 **Other adverse effects:**

No other information available.

## 12.2 **Battery lead paste:**

### 12.2.1 **Toxicity:**

#### **Aquatic toxicity:**

Battery lead oxide which is comparable to the inorganic lead compounds within a lead acid battery is classified as aquatic chronic 3, H412.

#### **Short term toxicity:**

Toxicity for fish 96 h LC 50 > 100 mg/l  
Toxicity for daphnia 48 h EC 50 > 100 mg/l  
Toxicity for alga 72 h IC 50 > 10 mg/l

### 12.2.2 **Bioaccumulative potential:**

Inorganic lead is considered to be bioaccumulative in the environment, and may accumulate in aquatic and terrestrial plants and animals. The following bioaccumulation/bioconcentration factors have been derived for Pb inorganic compounds:

### 12.2.3 **Aquatic compartment:**

Bioaccumulation/bioconcentration factors in freshwater: 1,553 L/kg (wet weight)

### 12.2.4 **Soil compartment:**

Bioaccumulation/bioconcentration factors in soil: 0.39 kg/kg (dry weight).

### 12.2.5 **Mobility in soil:**

This product contains inorganic lead compounds which are sparingly soluble and are expected to be adsorbed onto soils and sediments. Mobility is expected to be low.

### 12.2.6 **Results of PBT and vPvB assessment:**

The PBT and vPvB criteria in Annex XIII of the REACH Regulation do not apply to inorganic substances.

12.27 **Other adverse effects:**

No other information available.

13. **Disposal considerations:**

The point of sale, the manufacturers and importers of batteries take back used batteries, and render them to the secondary lead smelters for processing.

Clarios has established a collection system. More information is available on:

<http://www.clarios.com>

Spent lead-acid batteries (EWC 160601\*) are subject to the regulation of EU (Battery Directive) and its adoptions into national legislation on the composition and end-of-life management of batteries. They are marked with the recycling / return symbol and with a crossed-out roller container. Other battery chemistries have to be separated from lead-acid batteries to avoid any risks during collection, transport and recycling.

By no means the electrolyte the diluted sulphuric acid be emptied in an unexpected manner. This process is to be carried out by processing companies.

14. **Transport information:**

Land Transport	Land Transport (ADR/RID)
	<p>UN N°: UN2794 Classification ADR/RID: Class 8 Proper Shipping Name: BATTERIES, WET, FILLED WITH ACID electric storage Packing Group ADR: not assigned Label required: Corrosive ADR/RID:</p> <p>Batteries are exempted from all ADR/RID regulations, if requirements of special provision 598 are met.</p> <p>New storage batteries when they are secured in such a way that they cannot slip, fall or be damaged they are provided with carryin devices, unless they are suitably stacked, e.g. on pallets there aren't any dangerous traces or acids on the outside they are protected against shor circuits</p>

Sea Transport	Sea Transport (IMDG Code)  UN N°: UN 2794 Classification: Class 8 Proper Shipping Name: BATTERIES, WET, FILLED WITH ACID electric storage  Packing Group: not assigned EmS: F-A, S-B Label required: Corrosive
Air Transport	Air Transport (IATA-DGR)  UN N°: UN 2794 Classification: Class 8 Proper Shipping Name: BATTERIES, WET, FILLED WITH ACID electric storage Packing Group: not assigned Label required: Corrosive

15. **Regulatory information:**

In accordance with Battery Directive and national laws lead-acid batteries have to be marked by a crossed out refuse bin with the chemical symbol for lead Pb shown below, together with the ISO return/recycling symbol.

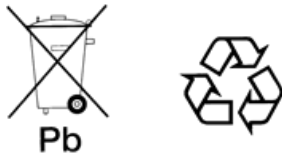

The manufacturer, respectively the importer of the batteries shall be responsible for labelling batteries with the symbols. In addition, a consumer / user information on the significance of the symbols has to be attached.

16. **Other information:**

16.1 **Key or legend to abbreviations and acronyms:**

- AF - Assessment factor
- CLP - Regulation (EC) No 1272/2008 of the European Parliament and of the Council of 16 December 2008 on classification, labelling and packaging of substances and mixtures.
- DNEL - Derived no-effect level
- DSD - Council Directive 67/548/EEC (Dangerous Substances Directive)
- EC50 - Concentration of the substance that causes 50 % reduction of a certain effect on test organisms
- EWC - European Waste Catalogue
- LC50 - Concentration of the substance that causes 50 % mortality of the test population
- NOAEC - No observed adverse effect concentration
- NOAEL - No observed adverse effect level
- OECD - Organisation for Economic Co-operation and Development
- PBT/vPvB - Persistent, bioaccumulative and toxic/ very persistent and very bioaccumulative
- PNEC - Predicted no-effect concentration
- REACH - Regulation (EC) No 1907/2006 of the European Parliament and of the Council of 18 December 2006 concerning the Registration, Evaluation, Authorisation and Restriction of Chemicals
- STOT RE - Specific Target Organ Toxicity, Repeated Exposure
- STOT SE - Specific Target Organ Toxicity, Single Exposure
- STP - Sewage treatment plant

## 16.2 Emergency telephone numbers:

Europe-wide emergency number: 112

Contact a poison control centre. List of phone numbers:

**AUSTRIA** (Vienna Wien) +43 1 406 43 43; **BELGIUM** (Brussels Bruxelles) +32 70 245 245; **BULGARIA** (Sofia) +359 2 9154 409; **CZECH REPUBLIC** (Prague Praha) +420 224 919 293; **DENMARK** (Copenhagen) 82 12 12 12; **ESTONIA** (Tallinn) 112; **FINLAND** (Helsinki) +358 9 471 977; **FRANCE** (Paris) +33 1 40 0548 48; **GERMANY** (Berlin) +49 30 19240; **GREECE** (Athens Athinai) +30 10 779 3777; **HUNGARY** (Budapest) 06 80 20 11 99; **ICELAND** (Reykjavik) +354 525 111, +354 543 2222; **IRELAND** (Dublin) +353 1 8379964; **ITALY** (Rome) +3906 305 4343; **LATVIA** (Riga) +371 704 2468; **LITHUANIA** (Vilnius) +370 5 236 20 52 or +370 687 53378; **MALTA** (Valletta) 2425 0000; **NETHERLANDS** (Bilthoven) +31 30 274 88 88; **NORWAY** (Oslo) 22 591300; **POLAND** (Gdansk) +48 58301 65 16 or +48 58 349 2831; **PORTUGAL** (Lisbon Lisboa) 808 250 143; **ROMANIA** (Bucharest) +40 21 3183606; **SLOVAKIA** (Bratislava) +421 2 54 77 4166; **SLOVENIA** (Ljubljana) + 386 41 650500; **SPAIN** (Barcelona) +34 93 227 98 33 or +34 93 227 54 00 bleep 190; **SWEDEN** (Stockholm) 112 or +46 833 12 31 (mon-fri 9.00-17.00); **UNITED KINGDOM** (London) 112 or 0845 4647 (NHS Direct).

## 16.3 Disclaimer of Liability:

The information in this data sheet for safe handling of lead-acid batteries is provided in good faith based on existing knowledge. However, the information is provided without any warranty, express or implied, regarding its correctness. The conditions or methods of handling, storage, use or disposal of the article are beyond our control and may be beyond our knowledge. For this and other reasons, we do not assume responsibility and expressly disclaim liability for loss, damage or expense arising out of or in any way connected with the handling, storage, use or disposal of the article. This data sheet was prepared and is to be used only for this article.

Safety Data Sheets are required for substances and mixtures according REACH (1907/2006/EC). Such a requirement doesn't exist for articles like Lead Acid Batteries.

Clarios Germany GmbH & Co. KGaA is providing customers a "Data Sheet for Safe Handling of Lead Acid Batteries" to assure that customers receive sufficient safety information. The content of this Data Sheet is comparable to Safety Data Sheets.

More information is available:

<http://www.clarios.com/>